



**PRO-PAS**  
**INTERNATIONAL**



**SURGICAL**  
**INSTRUMENTS**  
**CATALOGUE**

[www.propasintl.com.pk](http://www.propasintl.com.pk)



## INTRODUCTION



Since 2005 Pro-Pas International customers have been benefitting from our outstanding industry knowledge and our ability to provide high-quality medical and beauty care Instruments. We bring years of industry experience to each and every customer and constantly strive to meet our goal of 100% customer's satisfaction.

Pro-Pas International believes on "Precision with Perfection" so all the instruments which we manufacture are sent to different well-reputed brands, organizations, NGO's, hospitals, surgeons and beauticians worldwide. Customers suggestions are seriously considered to make certain improvements in instruments.

We always provide our customers with a quote on instruments as per their required specifications. We not only dispatch customers' orders within the agreed time but also help our regular customers to meet their urgent orders by maintaining stock for selective regular instruments in our factory. Sample orders are accepted from potential customers so they could evaluate the quality of our instruments before they place bulk orders.

Being a manufacturer, our prices are very competitive and affordable for all the customers. Regarding packaging and marking of instruments, we offer branding services to all customers and if they want to mark their company logo or brand name on their instruments and packaging, we are fully capable to do that. If you have any question please feel free to ask. Our team is always available to assist you any time.







DIAGNOSTICS SET	03 - 09
SURGICAL HANDLES	10 - 12
STERILE BLADES	13
SKIN GRAFTING KNIVES	14
SCISSORS	15 - 19, 23 - 24
DELICATE SCISSORS	20
ORAL, DELICATE SCISSORS	21
ORAL SCISSORS	22
"TC" SCISSORS	25 - 36
"TC" DISSECTING FORCEPS	37 - 40
TISSUE FORCEPS	41 - 42, 56 - 59, 79
DISSECTING & LIGATURE FORCEPS	43 - 44
SPLINTER FORCEPS	45
TOOTHED DISSECTING FORCEPS	46 - 49
DELICATE DISECTING FORCEPS	50 - 51
SERRATED DISSECTING FORCEPS	52 - 55
HAEMOSTATS FORCEPS	60 - 66
DRESSING FORCEPS	67
SPONGE HOLDING FORCEPS	68
TOWEL CLAMPS	69
TONGUE DEPRESSORS	70 - 71
NEEDLE HOLDERS	72 - 78
MICRO NEEDLE HOLDERS	80
"TC" NEEDLE HOLDERS	81 - 88
DISSECTORS	89 - 90
PROBES	91 - 92
TROCARS	93
SELF RETAINING RETRACTORS	94 - 101, 103
RETRACTOR	102, 105
HAND HELD RETRACTORS	104, 106 - 120
INTESTINAL CLAMPS	121 - 124
CHOLECYSTECTOMY AND GALL STONE FORCEPS	125
GALL DUCT PROBES	126
CHOLECYSTECTOMY & GALL STONE	127 - 128
VAGINAL SPECULUM	129, 131 - 134
VAGINAL RETRACTOR/UTERINE DILATORS	130
UROLOGY	135 - 139
HAEMORRHOIDAL SYRINGES	140
PROCTOLOGY HAEMORRHOIDAL IGATORS	141
SIGMOIDOSCOPY / BIOSPY	142, 143
PROCTOLOGY	144 - 145
HYSTERECTOMY CLAMPS	146
PERITONEUM INSTRUMENTS	147
OBSTETRICS INSTRUMENTS	148
UTERINE CANNULAE	149
CERVICAL BIOPSY FORCEPS	150 - 152
OVUM FORCEPS	153-154
MALLETS	155 - 156
OSTEOTOMES, CHISELS & GOUGES	157
BONE SCOOPS	158
RASPATORIES	159 - 161
BONE LEVERS	162 - 164
ELEVATORS	164
AMPUTATION INSTRUMENTS	165 - 166
SUCTION TUBES	167 - 168
ATRAUMA CARDIOVASCULAR FORCEPS	169 - 170, 186 - 194, 196
ATRAUMA BULLDOG CLAMPS	171, 195
RIB SPREADERS	172 - 174
BONE & RIB SHEARS	175
PLASTER CAST REMOVAL INSTRUMENTS	176
BONE CUTTING FORCEPS	177
DISC RONGEURS	178
BONE RONGEURS	179 - 181
BONE HOLDING FORCEPS	182
TUNNELING SET	183
VASCULAR DILATORS	184
DILATORS	185







**Set  
3001**



**Set  
3002**







Set  
3003



Set  
3004







**Set  
3005**



**Set  
3006**







**Set  
3007**



**Set  
3008**







3009



3011



3010



3013



3012



Set  
3014







Set  
3015



Set  
3016





Set  
3017



Set  
3018







**No.4L**  
3019



**ERGONOMIC**  
3020



**No.7**  
3021



**No. 3**  
3022





3023



3024



3025



No.3L  
3026







**No.10**  
3027



**No.4**  
3028



**No.9**  
3029



**BARRON**  
3030  
For "B.P." type blades  
for use with No's 10,11,12  
& 15 blades  
135mm (5.1/4")





3031



3032



3033



3034



3035



3036



3037



3038



3039



3040



3041



3042







**SILVER**

3043  
Skin Graft Knife  
without blade  
190mm (7.1/2")



**WATSON**

3044  
Skin Graft Knife  
without blade  
300mm (12")

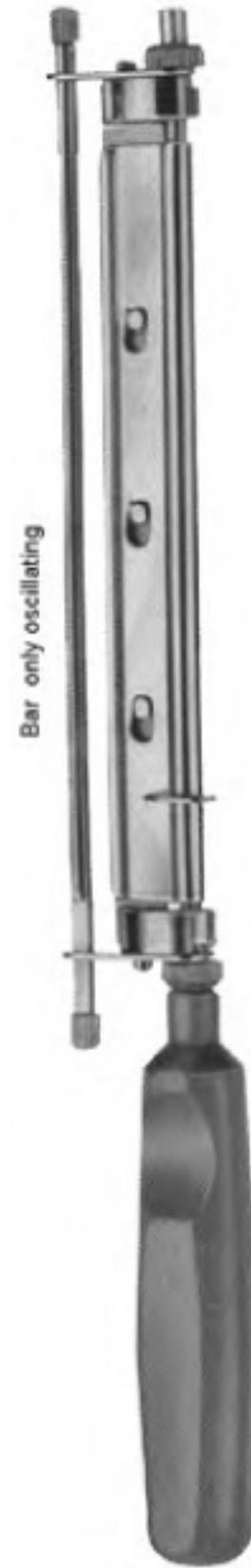

**COBBETT**

3045  
Skin Graft Knife  
without blade  
315mm (12.2/3")



**MAYO**  
Straight, bevelled blades



**3046**  
140 mm  
(5.1/2")

**3047**  
190 mm  
(7.1/2")



**3048**  
170 mm  
(6.3/4")

**3049**  
215mm  
(8.1/2")



**3050**  
140 mm  
(5.1/2")

**3051**  
190 mm  
(7.1/2")



**3052**  
170 mm  
(6.3/4")

**3053**  
215mm  
(8.1/2")

Curved on flat, bevelled blades



**MAYO**  
Round Blades



**3054**  
170 mm  
(6.3/4")

200mm  
(8")  
Straight



**3055**  
140mm  
(5.1/2")

150 mm  
(6")  
Straight



**MAYO**  
Round Blades



**3056**  
170 mm  
(6.3/4")

200mm  
(8")  
Curved on  
flat



**3057**  
140mm  
(5.1/2")

150 mm  
(6")  
Curved on  
flat





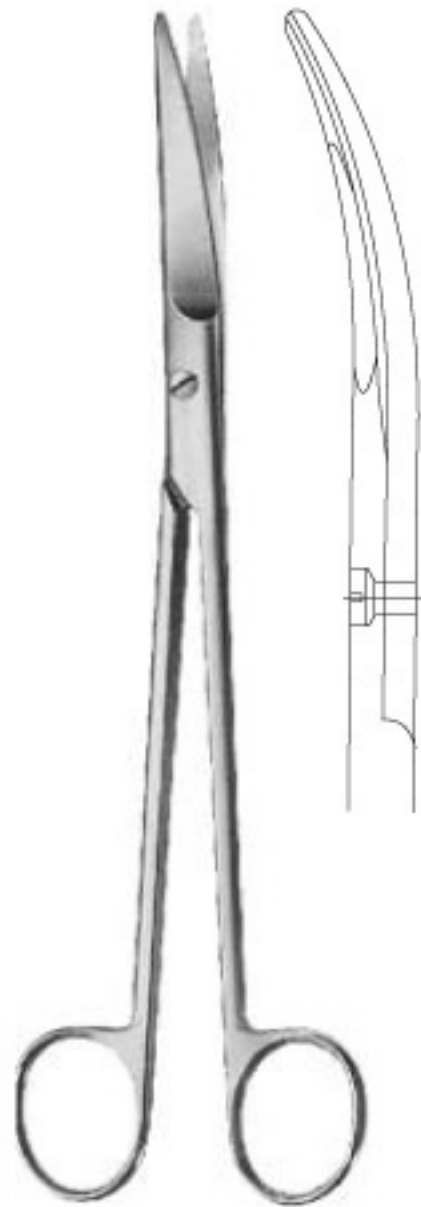

**MAYO HARRINGTON**  
**3058**  
225mm (9")  
Curved on flat, blunt points

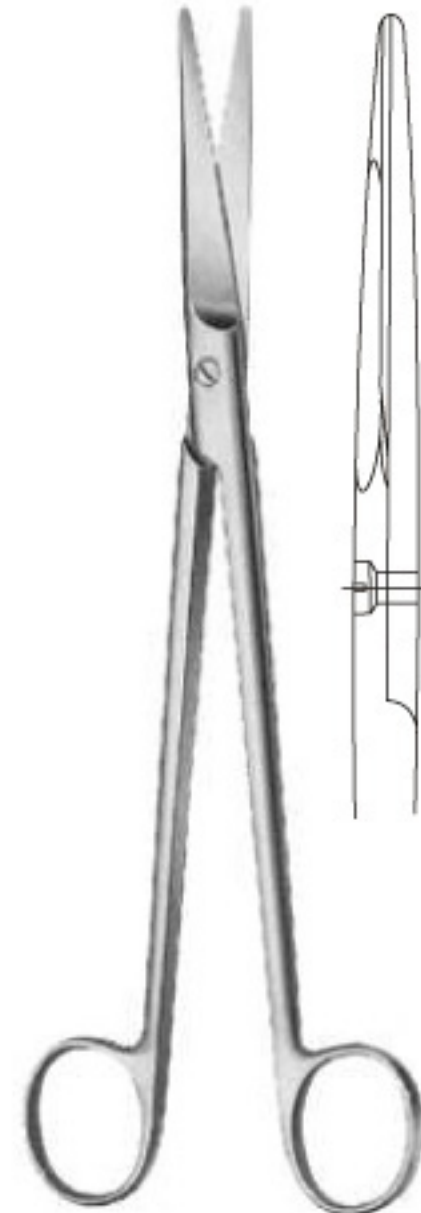

**MAYO HARRINGTON**  
**3059**  
225mm (9")  
Straight, blunt points



**MAYO (STILLE)**



**3060**  
170 mm  
(6.3/4")  
Straight



**3061**  
150 mm  
(6")  
Straight



**3062**  
170 mm  
(6.3/4")  
Curved on  
flate



**3063**  
150 mm  
(6")  
Curved on  
flate





**METZENBAUM**

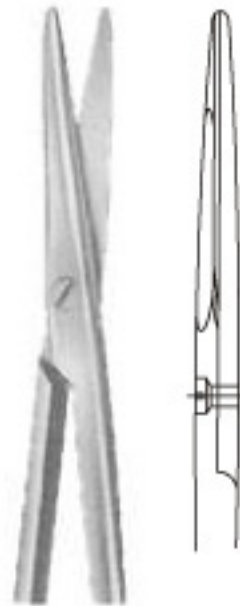

**METZENBAUM**  
Straight, blunt points  
3064  
115mm (4.1/2")  
3065  
145mm (5.3/4")  
3066  
180mm (7")  
3067  
200mm (8")



**METZENBAUM**  
Curved on flat, blunt points  
3070  
115mm (4.1/2")  
3071  
145mm (5.3/4")  
3072  
180mm (7")  
3073  
200mm (8")

**METZENBAUM (Nelson)**  
Straight  
3068  
230mm (9")  
3069  
250mm (10")

**METZENBAUM (Nelson)**  
Curved on flat  
3074  
230mm (9")  
3075  
250mm (10")

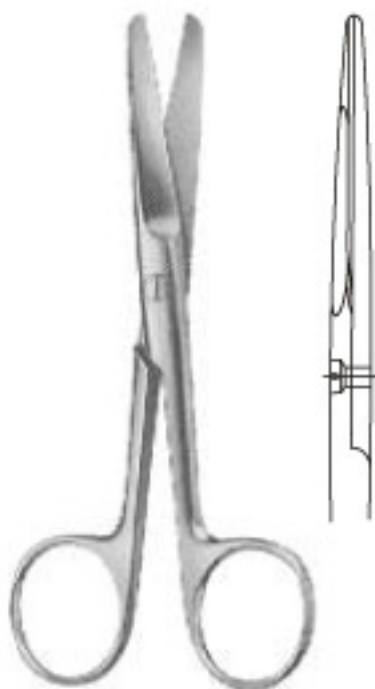

**DRESSING**  
Straight, blunt / blunt points  
3076  
125mm (5")  
3077  
145mm (5.3/4")  
3078  
150mm (6")  
3079  
180mm (7")  
3080  
200mm (8")

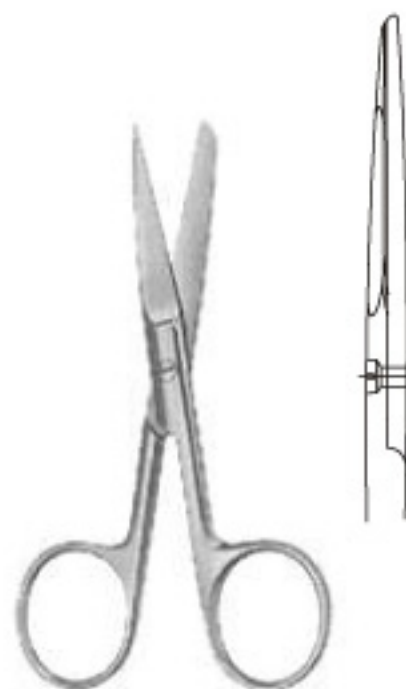

**DRESSING**  
Straight, sharp / blunt points  
3081  
125mm (5")  
3082  
145mm (5.3/4")  
3083  
150mm (6")  
3084  
180mm (7")  
3085  
200mm (8")

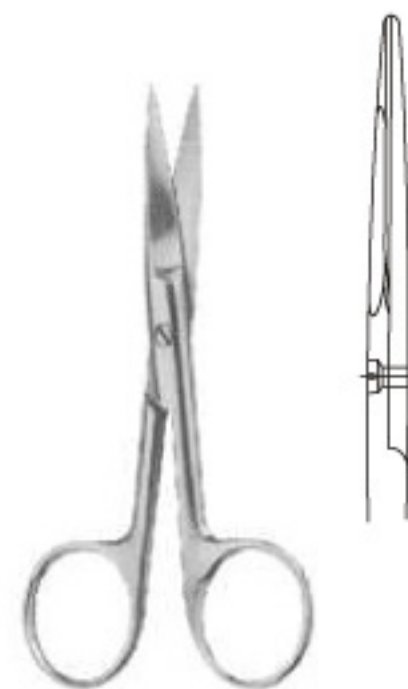

**DRESSING**  
Straight, sharp / Sharp points  
3086  
125mm (5")  
3087  
145mm (5.3/4")  
3088  
150mm (6")  
3089  
180mm (7")  
3090  
200mm (8")







**CRAFOORD**

3091  
305mm (12")  
Straight

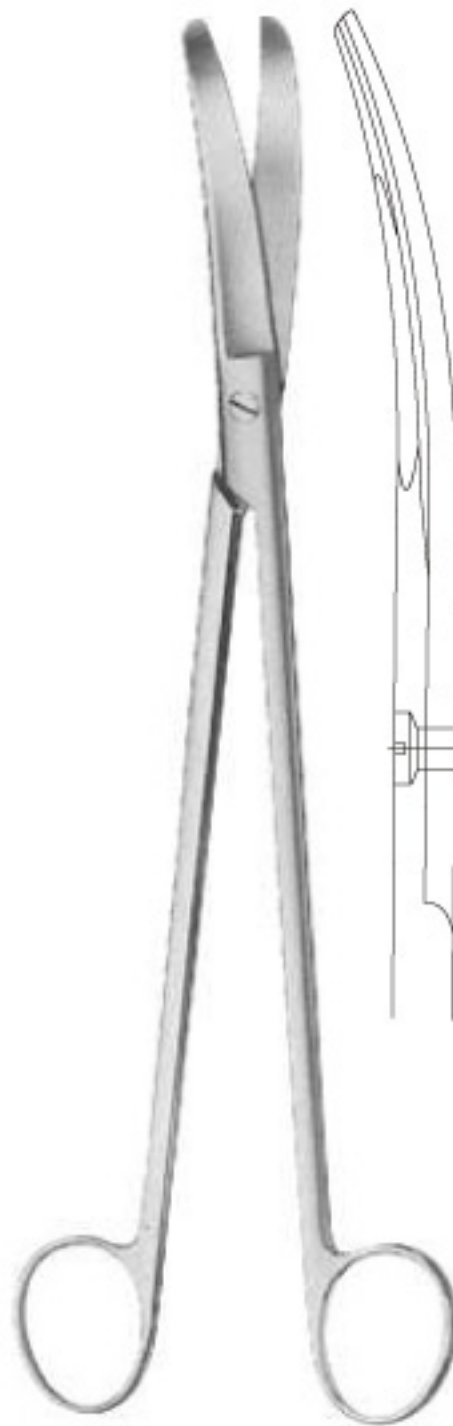

**LLOYD DAVIS RECTAL**  
blunt points, flat blades

3092  
255mm (10")  
Curved on flat  
3093  
255mm (10")  
Straight

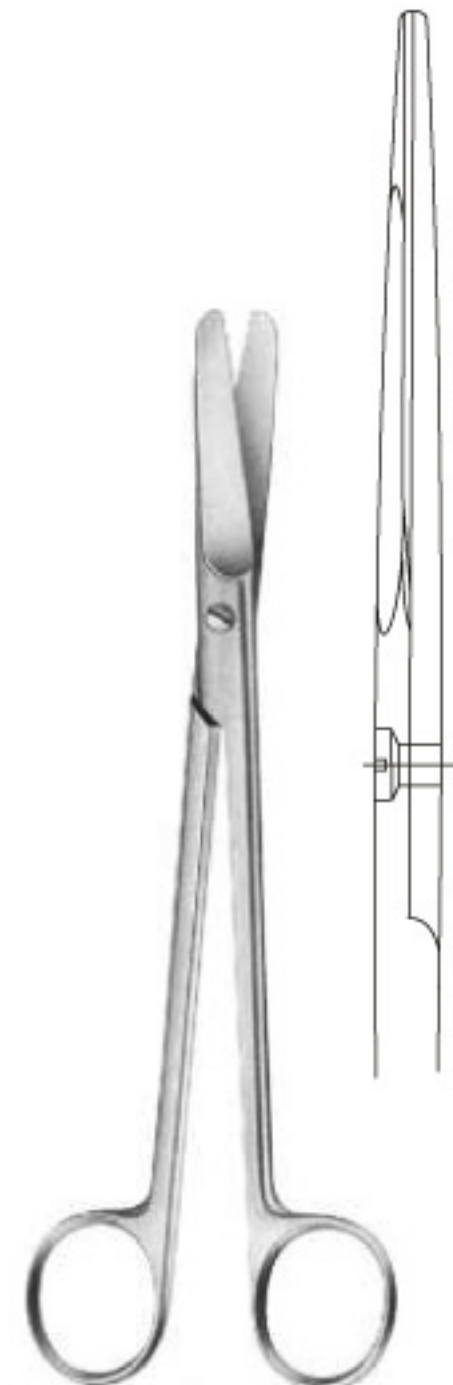

**UTERINE**

3094  
230mm (9")  
Straight. blunt points





**AUFRICHT**  
150mm (6")  
Lightweight

**3095**  
Straight

**3096**  
Curved on flat



**KILNER**

**3097**  
110mm (4.1/2")  
Straight, sharp points

**3098**  
110mm (4.1/2")  
Curved on flat, blunt points

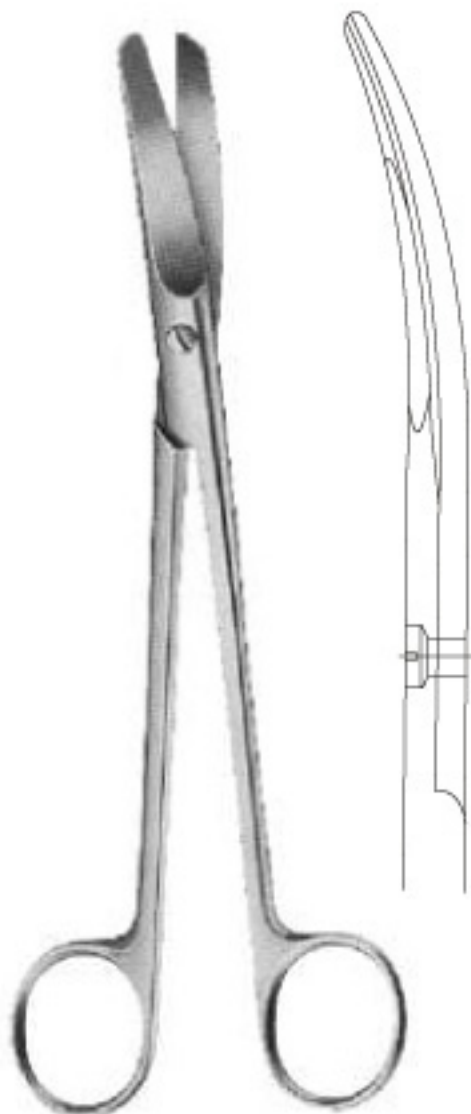

**UTERINE**  
Curved on flat, blunt points

**3099**  
200mm (8")

**3100**  
230mm (9")



**BRAUN STADTLER  
EPISIOTOMY**  
Angled blades

**3101**  
145mm (5.3/4")

**3102**  
200mm (8")



**AMERICAN PATTERN  
UMBILICAL**  
Angled blades

**3103**  
100mm (4")





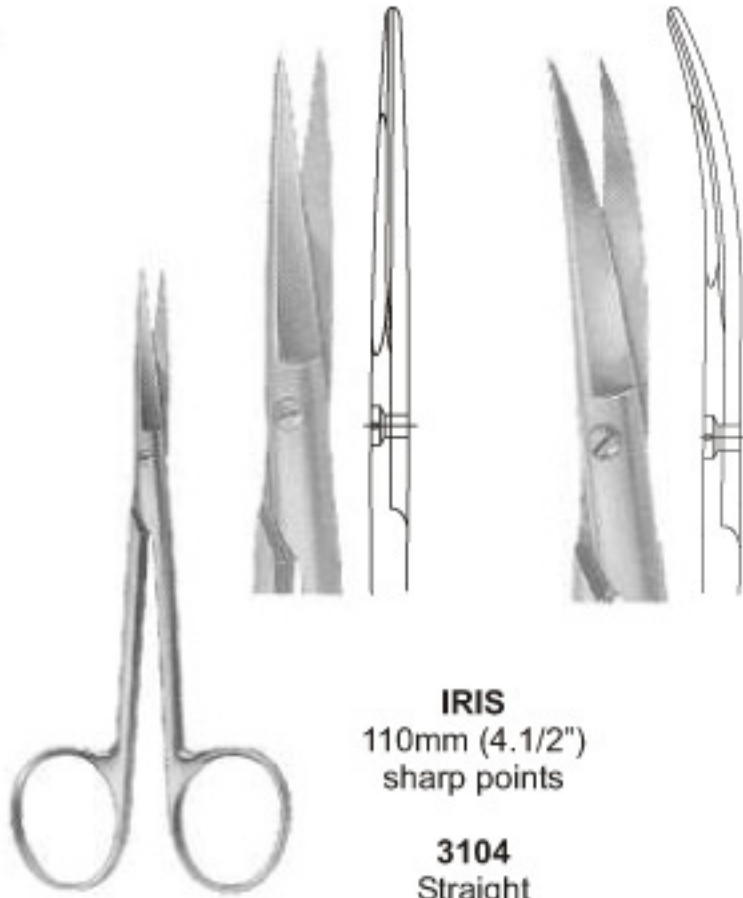

**IRIS**  
110mm (4.1/2")  
sharp points

**3104**  
Straight

**3105**  
Curved on flat



**IRIS**  
110mm (4.1/2")  
Round blades, sharp points

**3106**  
Straight

**3107**  
Curved on flat



**IRIS**

**3108**  
90mm (3.1/2")  
Curved on flat, lightweight  
sharp points



**STRABISMUS**

**3109**  
110mm (4.1/2")  
Straight

**3110**  
110mm (4.1/2")  
Curved on flat





**SCHUKNECHT  
WIRE CUTTING**

**3111**  
125mm (5")



**HEYMANN  
TURBINECTOMY**

**3112**  
185mm (7.1/4")  
Angled shanks  
blunt points



**STEVENS TENOTOMY**  
110 mm (4.1/4")

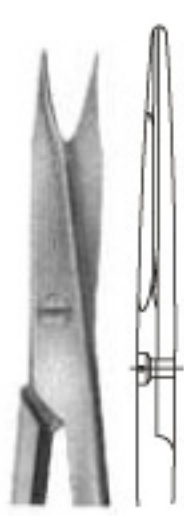

**3113**  
straight,  
sharp points

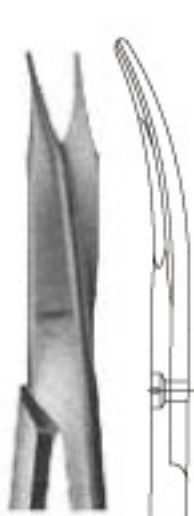

**3114**  
Curved on flat  
sharp points



**3115**  
straight,  
blunt points

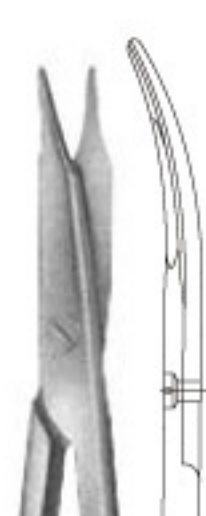

**3116**  
Curved on flat  
blunt points







**WOODS TONSIL**

**3117**  
190mm (7.1/2")  
Curved on flat  
sharpened  
outer edge, blunt



**WHEELER TONSIL**

**3118**  
200mm (8")  
Curved on flat

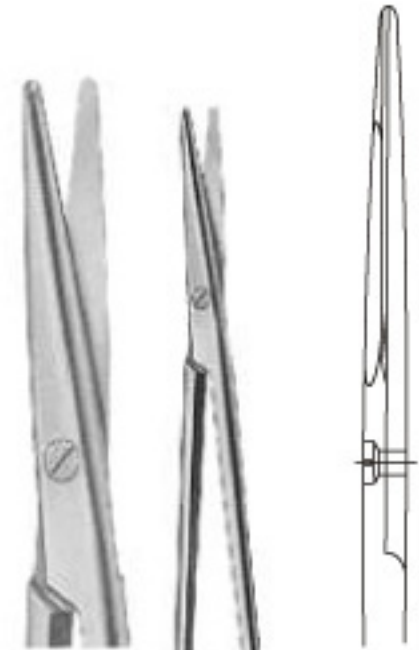

**WILSON TONSIL**

**3119**  
180mm (7")  
Straight



**POTTS**

**3120**  
190mm (7.1/2")  
Angled on flat  
45 degrees

**3121**  
190mm (7.1/2")  
Angled on side  
25 degrees

**3122**  
190mm (7.1/2")  
Angled on side  
45 degrees

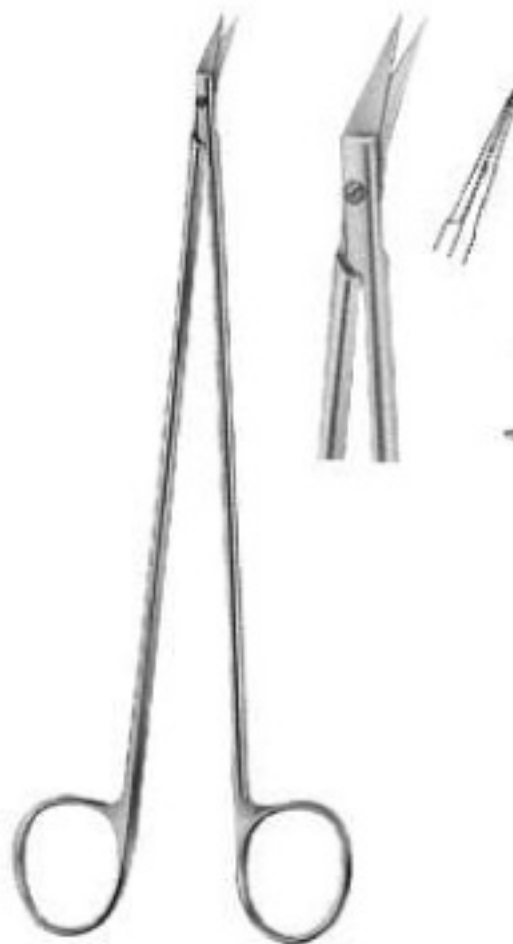
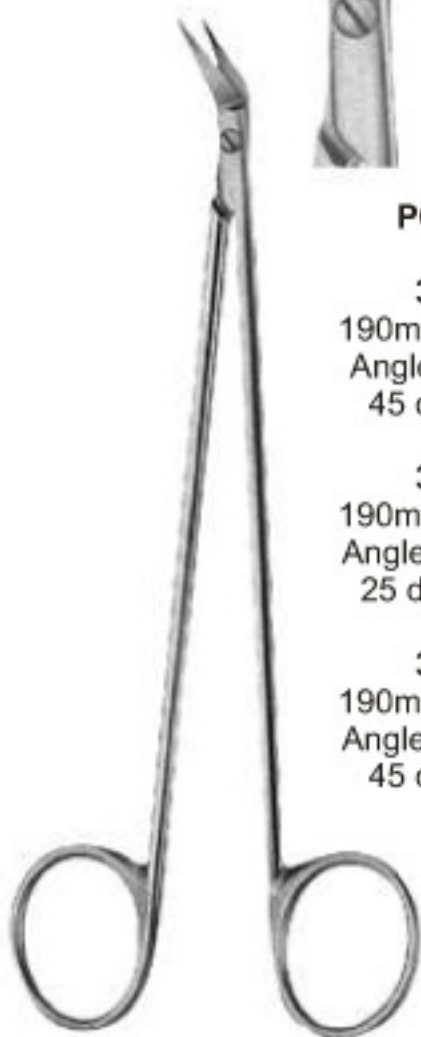

**HEDGEMAN (DIETRICH)**  
**3123**

175mm (7")  
Angled to side, 25 degrees

**3124**  
175mm (7")  
Angled to side, 45 degrees

**3125**  
175mm (7")  
Angled to side, 60 degrees

**3126**  
175mm (7")  
Angled to side, 90 degrees

**3127**  
175mm (7")  
Angled to side, 125 degrees



**FAVALORO**

**3128**  
150mm (6")  
Shanks curved,  
blades angled to side





**REYNOLDS**  
Curved on flat, tapered points

**3129**  
145mm (5.3/4")

**3130**  
180mm (7")

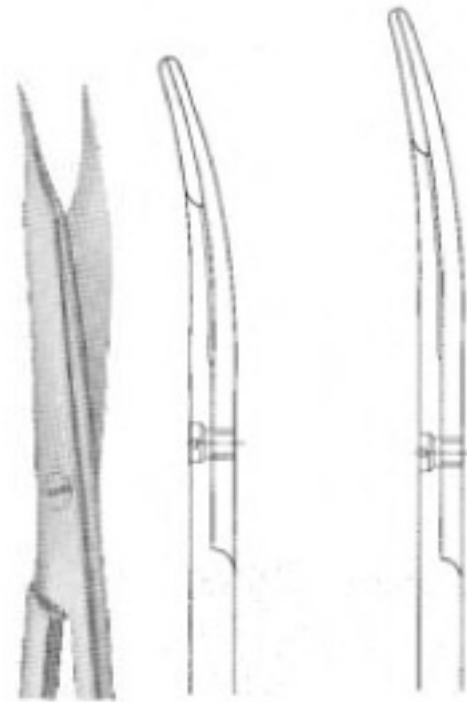

**DOYEN ABDOMINAL**

**3131**  
180mm (7")  
Curved, blunt points

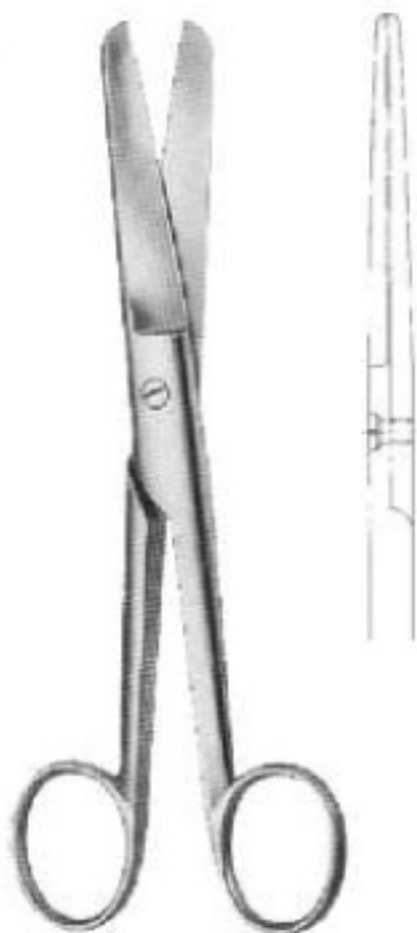

**DOYEN ABDOMINAL**

**3132**  
180mm (7")  
Straight, blunt points



**DOYEN ABDOMINAL**

**3133**  
210mm (8.1/4")  
One blade with hook end

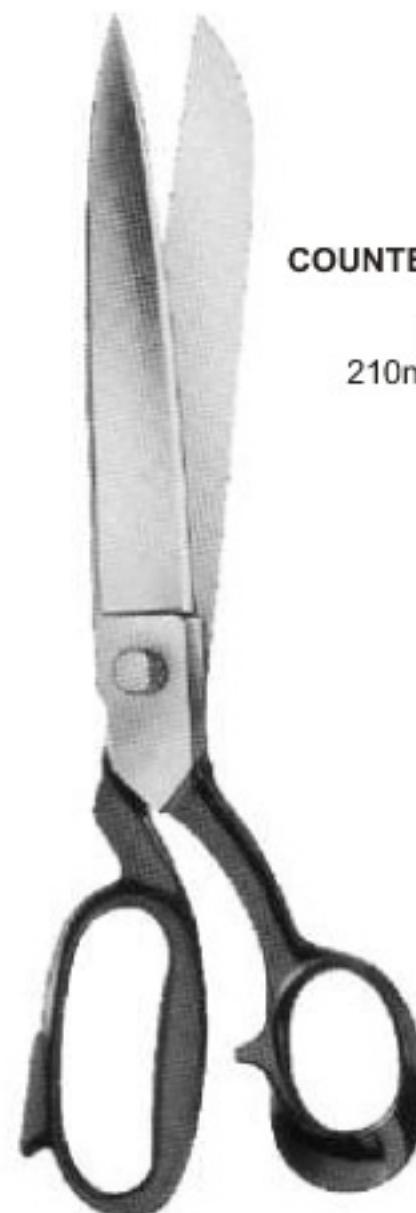

**COUNTER SCISSORS**

**3134**  
210mm (8.1/4")





**LISTER BANDAGE**

**3135**  
115mm (4.1/2")

**3136**  
140mm (5.1/2")

**3137**  
180mm (7")

**3138**  
200mm (8")

**3139**  
235mm (9.1/4")



**SCHUMACHER UMBILICAL**

**3140**  
155mm (6")

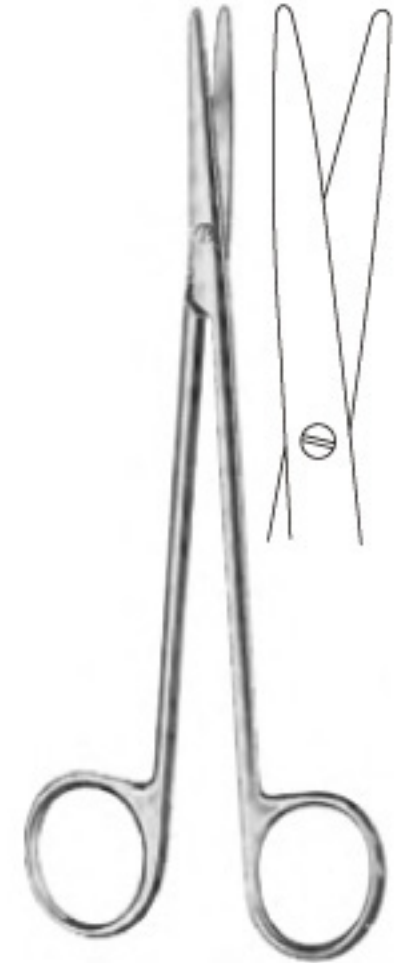

**MCINDOE SCISSORS**

**3141**  
180mm (7")  
Straight

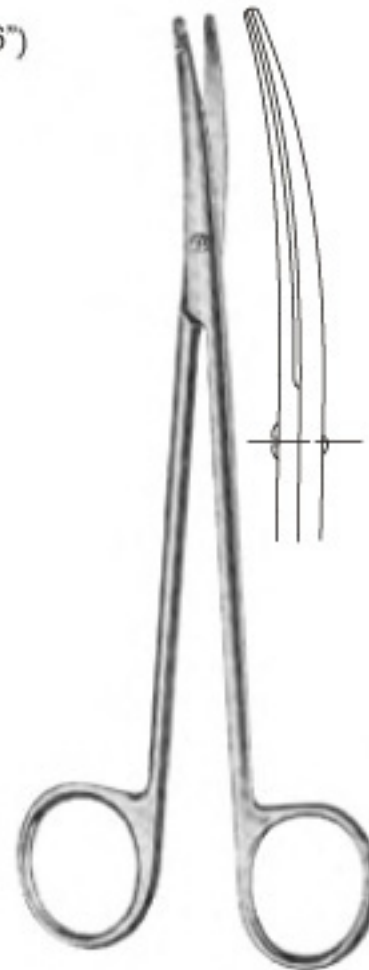

**MCINDOE SCISSORS**

**3142**  
180mm (7")  
Curved







**IRIS SCISSORS**  
110mm (4.3/8")



**3143**



**3144**

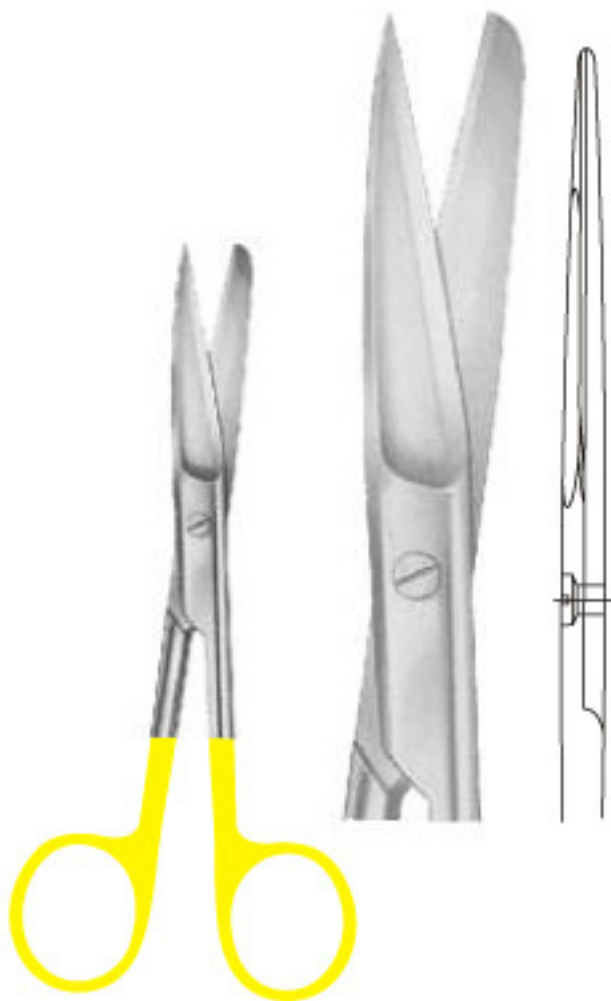

**SURGICAL SCISSORS**

- 3145**
- 130mm (5")
- 150mm (6")
- 180mm (7")

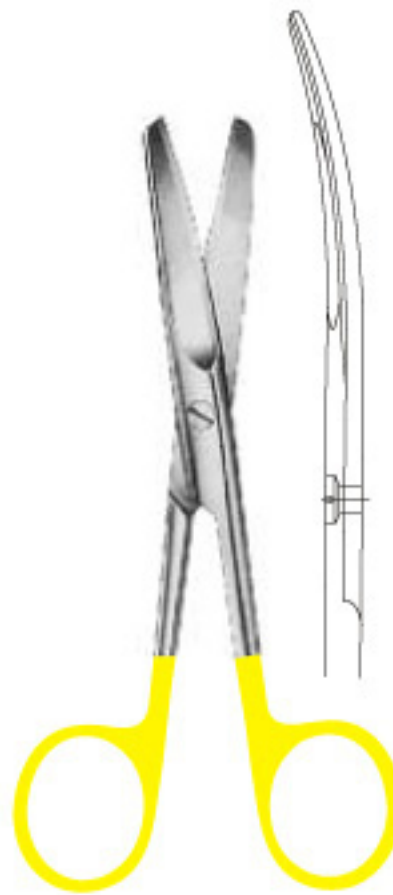

**SURGICAL SCISSORS**

- 3146**
- 130mm (5")
- 150mm (6")
- 180mm (7")

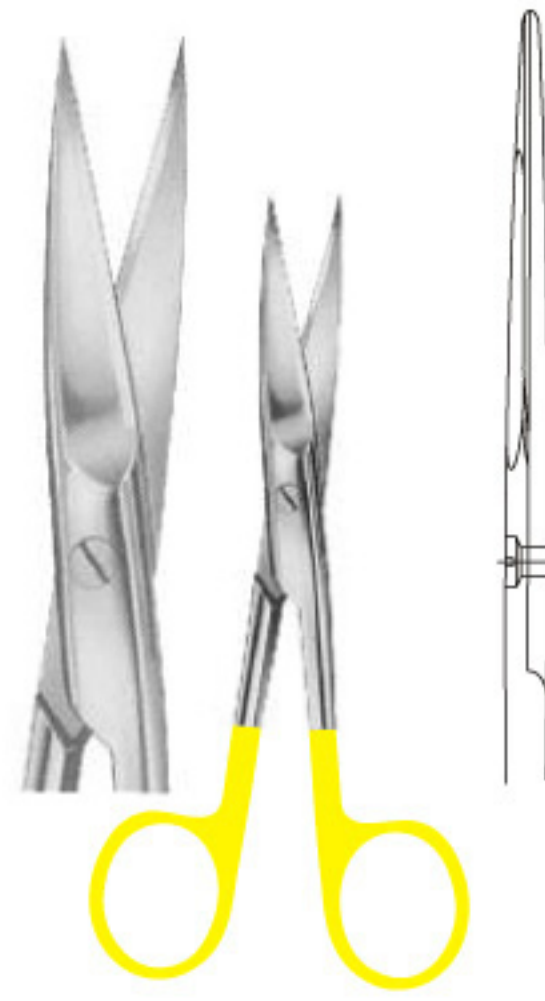

**SURGICAL SCISSORS**

- 3147**
- 130mm (5")
- 150mm (6")
- 180mm (7")



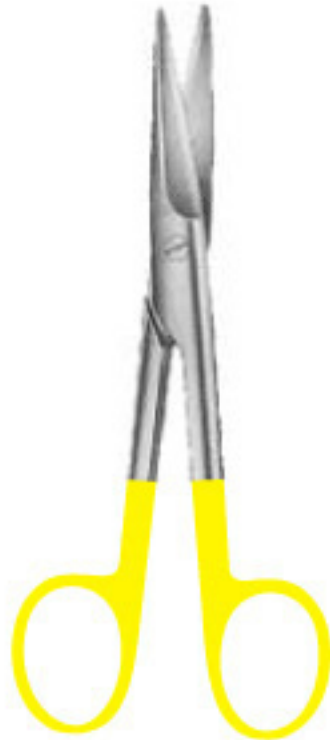

**MAYO  
DISSECTING  
SCISSORS**



**3148**  
140mm (5.1/2")  
150mm (6")  
180mm (7")  
200mm (8")  
230mm (9")



**3149**  
140mm (5.1/2")  
150mm (6")  
180mm (7")  
200mm (8")  
230mm (9")

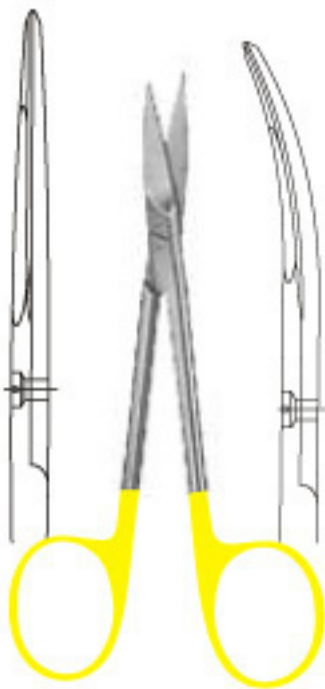

**DELICATE SCISSORS**  
120mm (4.3/4")

**3150** Straight

**3151** Curved



**STRABISMUS SCISSORS**  
115mm (4.1/2")

**3152** Straight

**3153** Curved

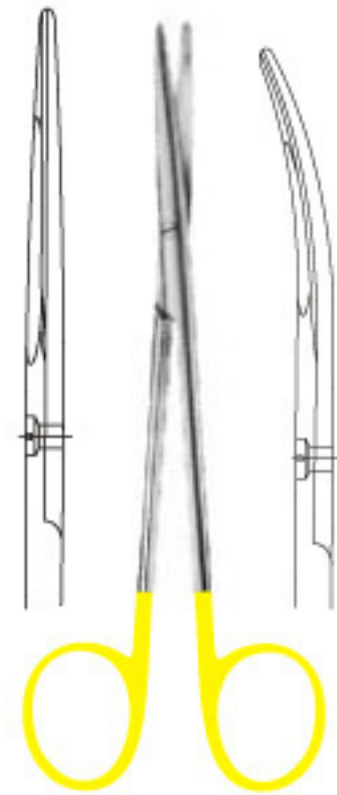

**BABY METZANBAUM**  
145mm (5.3/4")

**3154** Straight

**3155** Curved



**"TC" SCISSORS**



**METZENBAUM**  
Round Blade Straight



**3156**  
180mm (7")



**3157**  
145mm (5.3/4")



**3158**  
180mm (7")



**3159**  
200mm (8")



**3160**  
145mm (5.3/4")



**3161**  
180mm (7")



**3162**  
200mm (8")



**3163**  
230mm (9")



**3164**  
180mm (7")



**3165**  
200mm (8")



**3166**  
230mm (9")





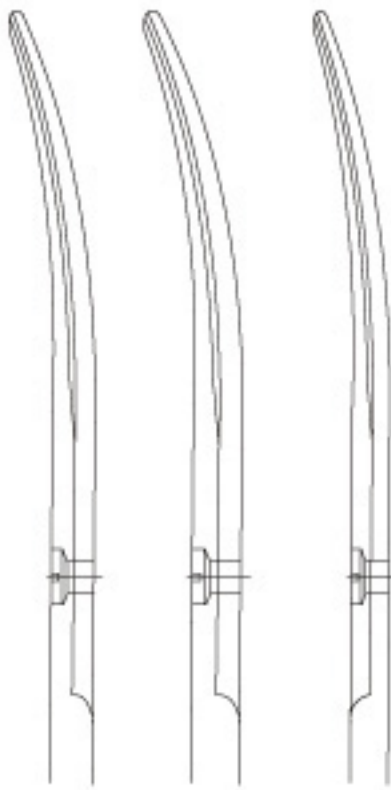

**NELSON - METZENBAUM**

**3167**  
260mm (10.1/4")

**3168**  
280mm (11")

**3169**  
285mm (11.1/4")



**NELSON - METZENBAUM**  
Dissecting Scissors

**3170**  
230mm (9")

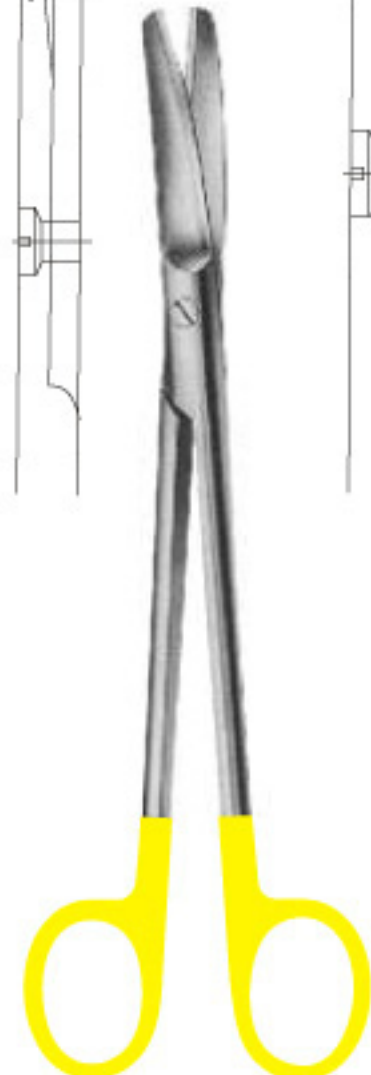

**SIMS**

**3171**  
200mm (8")

**3172**  
230mm (9")





**LEXER**  
**3173**  
 165mm (6.1/2")

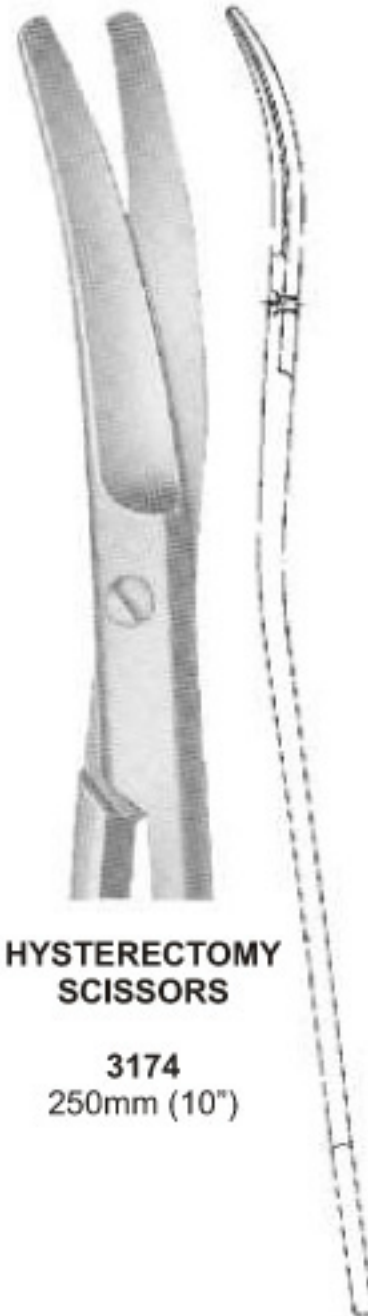
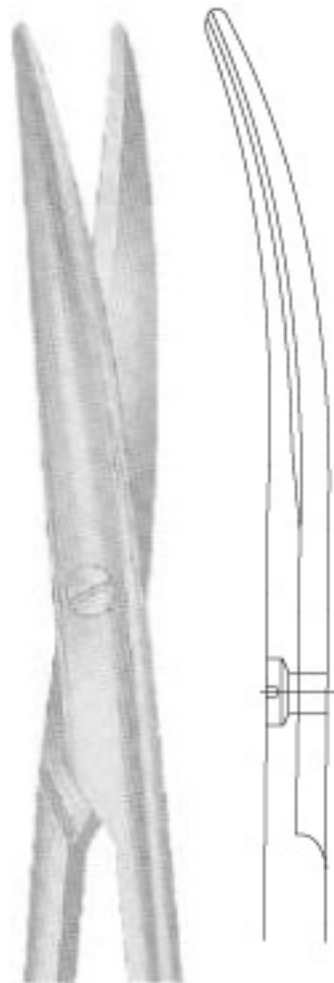

**HYSTERECTOMY SCISSORS**  
**3174**  
 250mm (10")

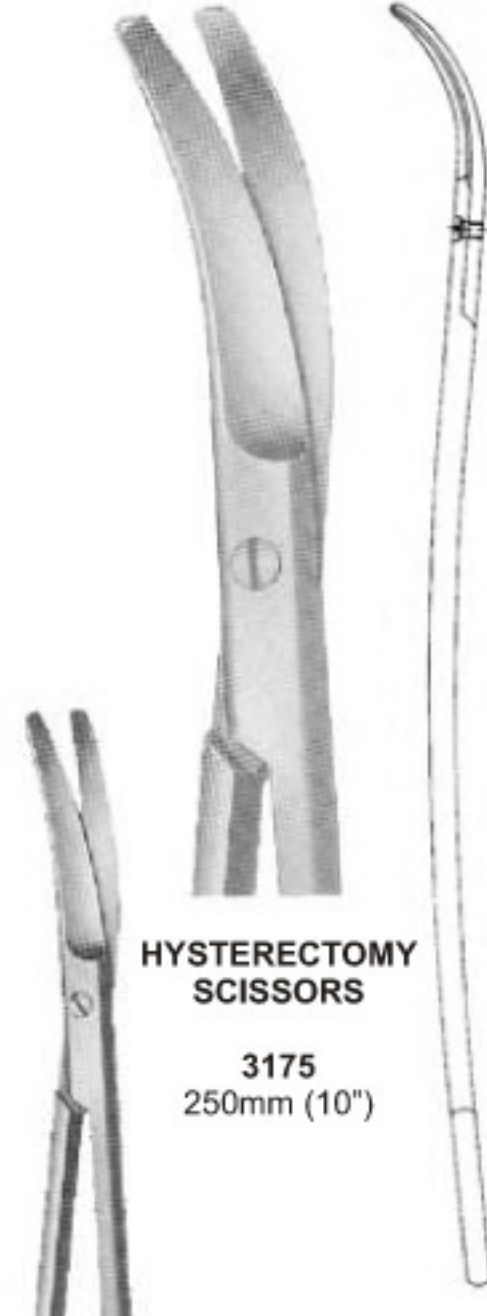

**HYSTERECTOMY SCISSORS**  
**3175**  
 250mm (10")

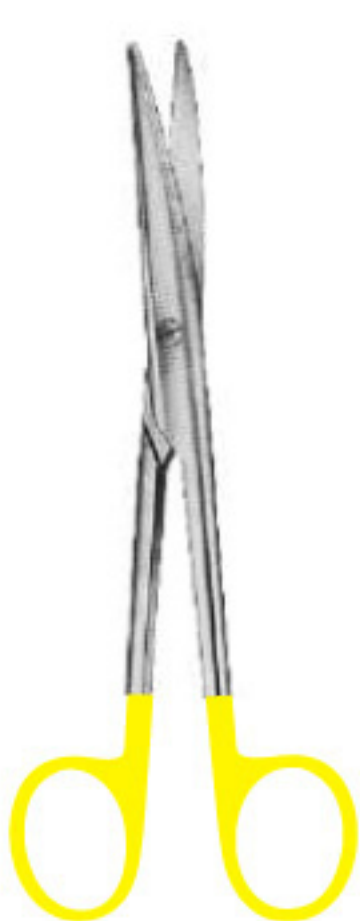

**MAYO-LEXER**  
**3176**  
 165mm (6.1/2")

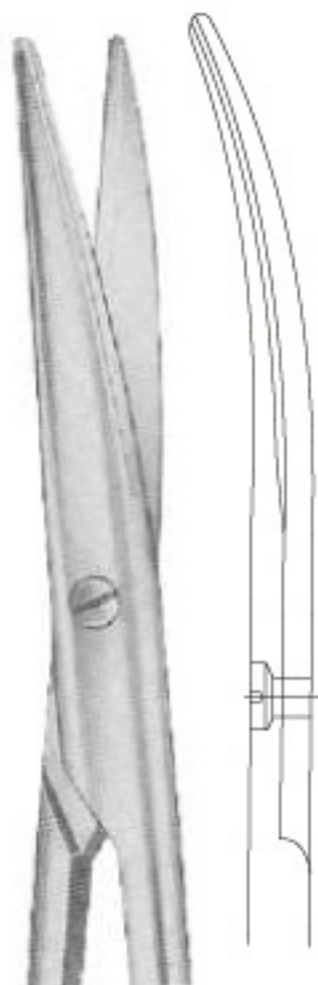

**HYSTERECTOMY SCISSORS**  
 Strongly curved to fit with parametriumclamps



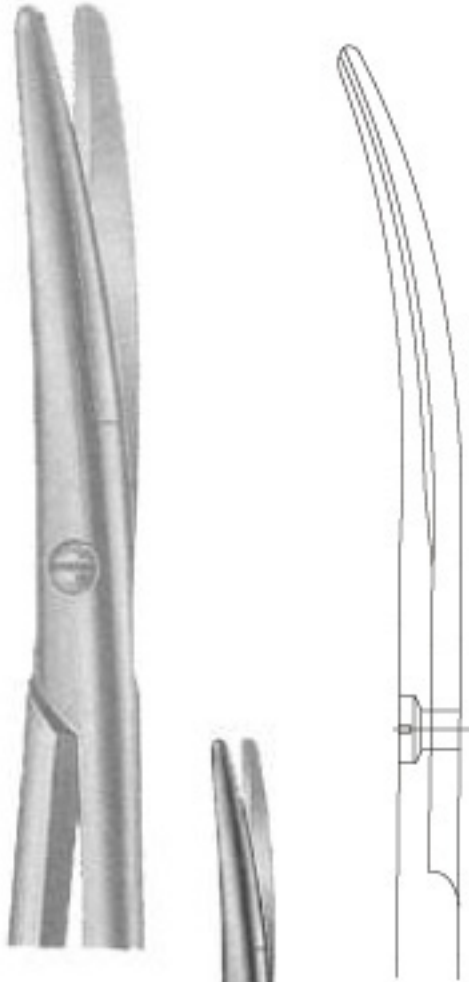

**METZENBAUM**  
**3178**  
230mm (9")  
With broad blade ends



**SIMS**  
**3179**  
230mm (9")

**SIMS**  
**3177**  
200MM (8")







**SIMS**

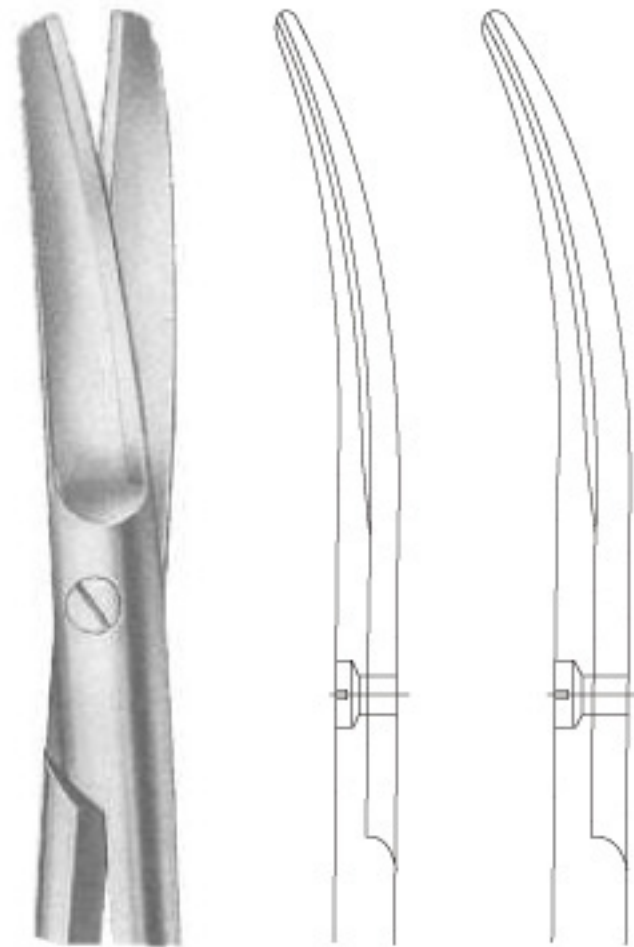

**3181**  
200mm (8")

**3182**  
230mm (9")



**METZENBAUM**

**3180**  
230mm (9")  
With broad blade ends

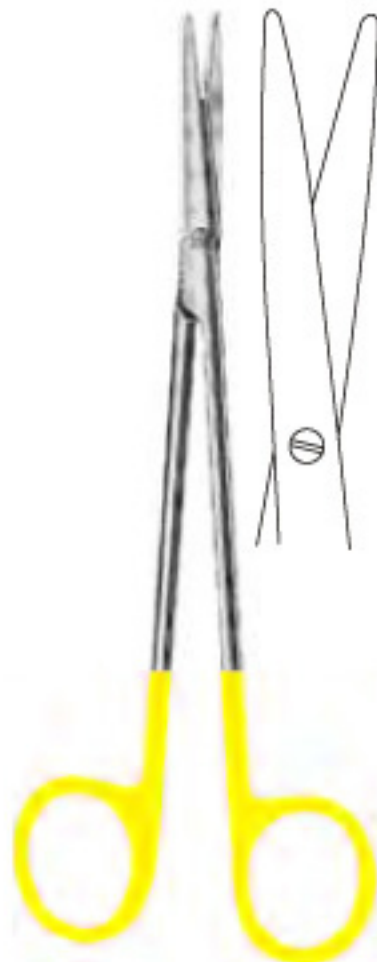

**MCINDOE SCISSORS**

**3183**  
180mm (7")  
Straight

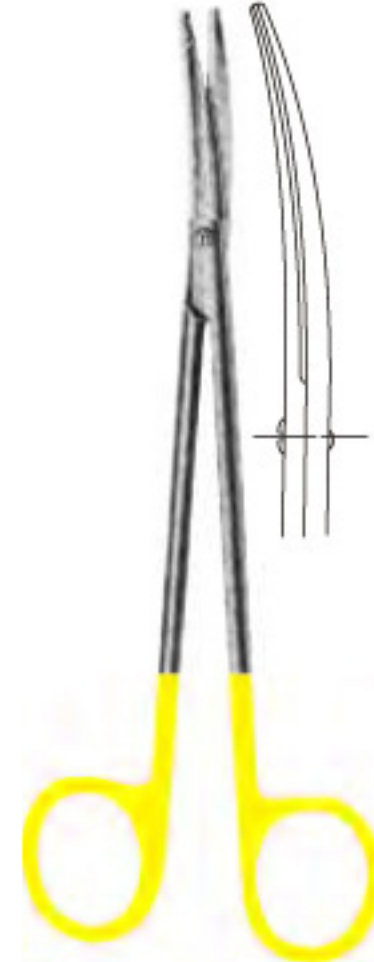

**MCINDOE SCISSORS**

**3184**  
180mm (7")  
Curved



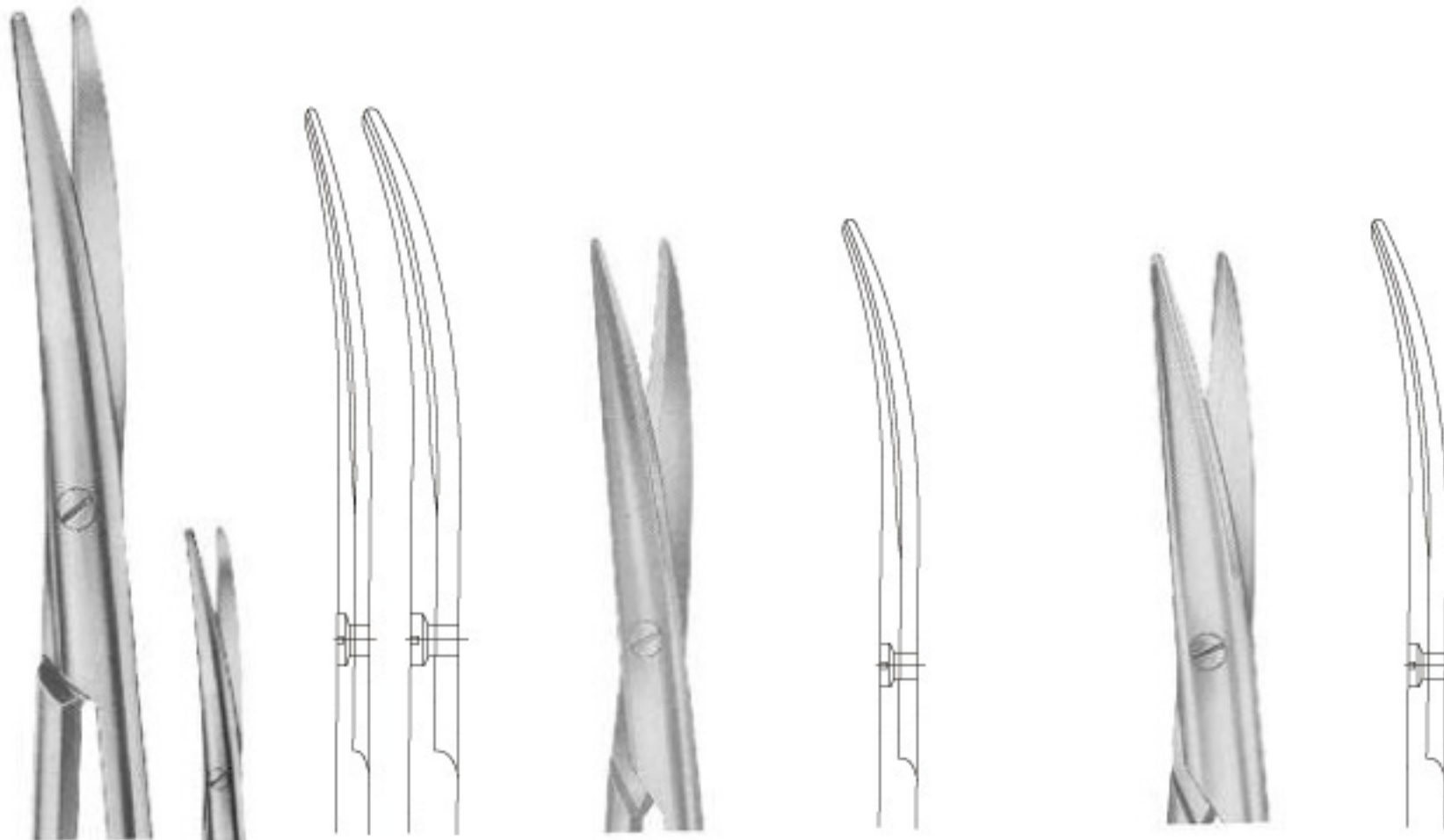

**NELSON-METZENBAUM**

**3185**  
260mm (10.1/4")

**3186**  
280mm (11")



**LEXER**  
Straight

**3187**  
165mm (6.1/2")



**MAYO - LEXER**  
Curved

**3188**  
165mm (6.1/2")



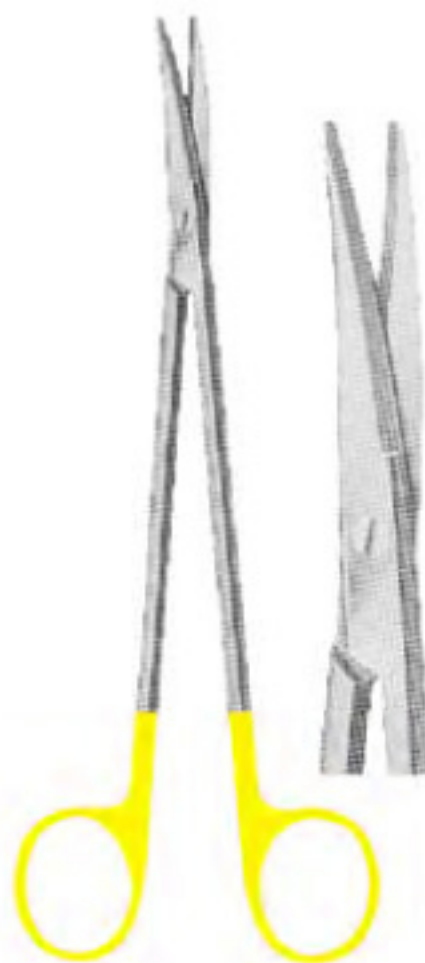
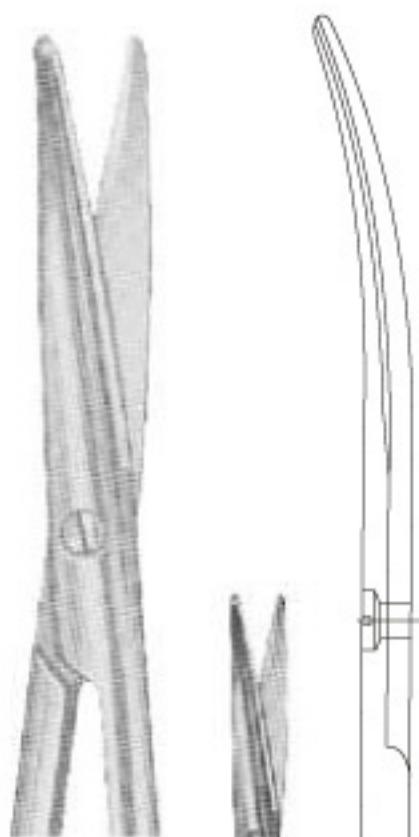

**METZENBAUM**



**3190**  
180mm  
(7")



**3191**  
200mm  
(8")



**3192**  
230mm  
(9")



**NELSON-METZENBAUM**

**3189**  
230mm (9")



**TOENNIS ADSON**



**3193**  
175mm (7")





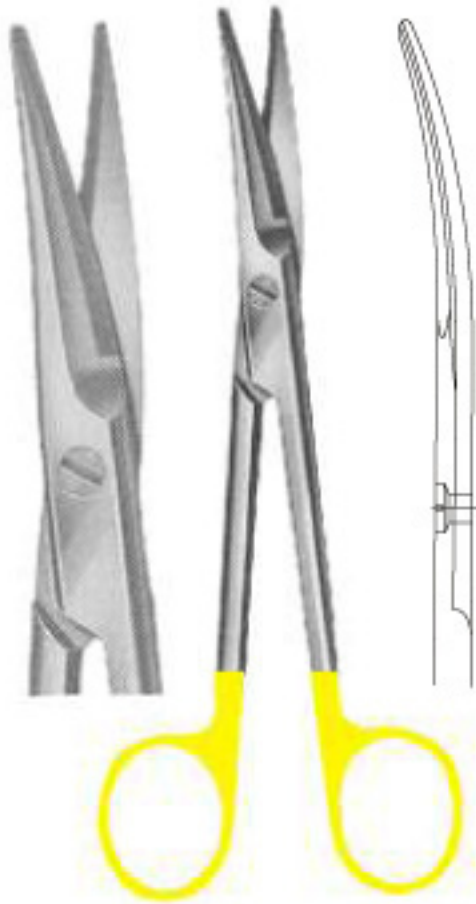

**MAYO**

**3194**  
170mm (6.3/4")  
Dissecting Scissors

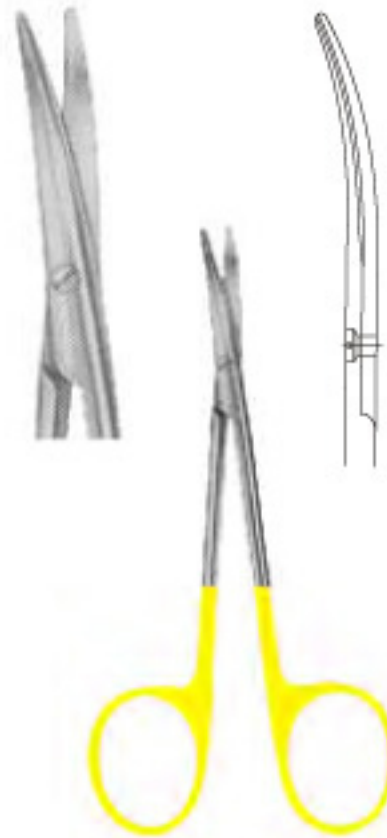

**METZENBAUM DELICATE**

**3195**  
115mm (4.1/2")

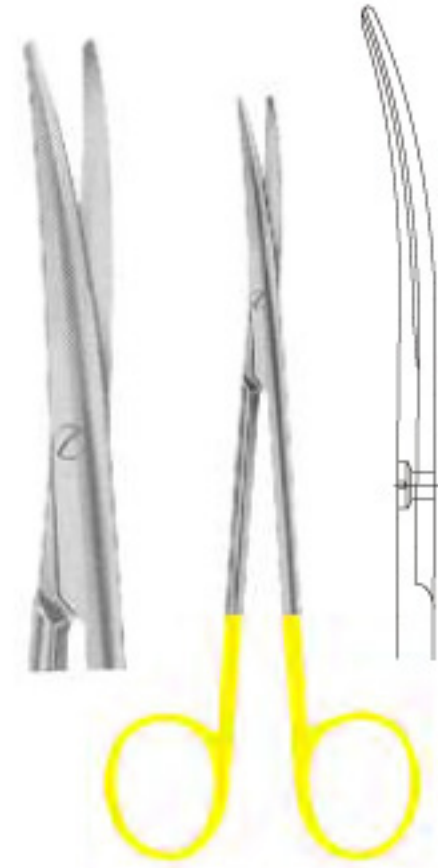

**BABY METZENBAUM**

**3196**  
145mm (5.3/4")  
**3197**  
180mm (7")  
**3198**  
200mm (8")



**METZENBAUM**



**3199**  
145mm (5.3/4")



**3200**  
180mm (7")



**3201**  
200mm (8")





**DEBAKEY  
VASCULAR SCISSORS**

**3202**  
220mm (8.3/4")

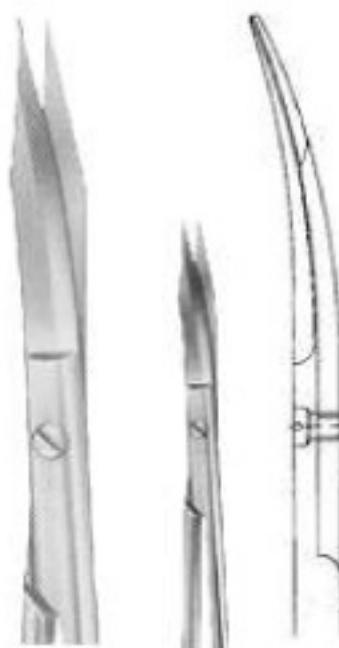

**3203**  
Sharp Point  
130mm (5.1/8")  
1 blad serrated



**IRIS DELICATE**

**3205**  
110mm (4.3/8")



**3204**  
120mm (4.3/4")  
Wire cutting scissors  
1 blade serrated



**DRESSING SCISSORS**

**3206**  
145mm (5.3/4")





**3207**

**REYNOLDS SCISSORS**  
150mm (6")  
180mm (7")

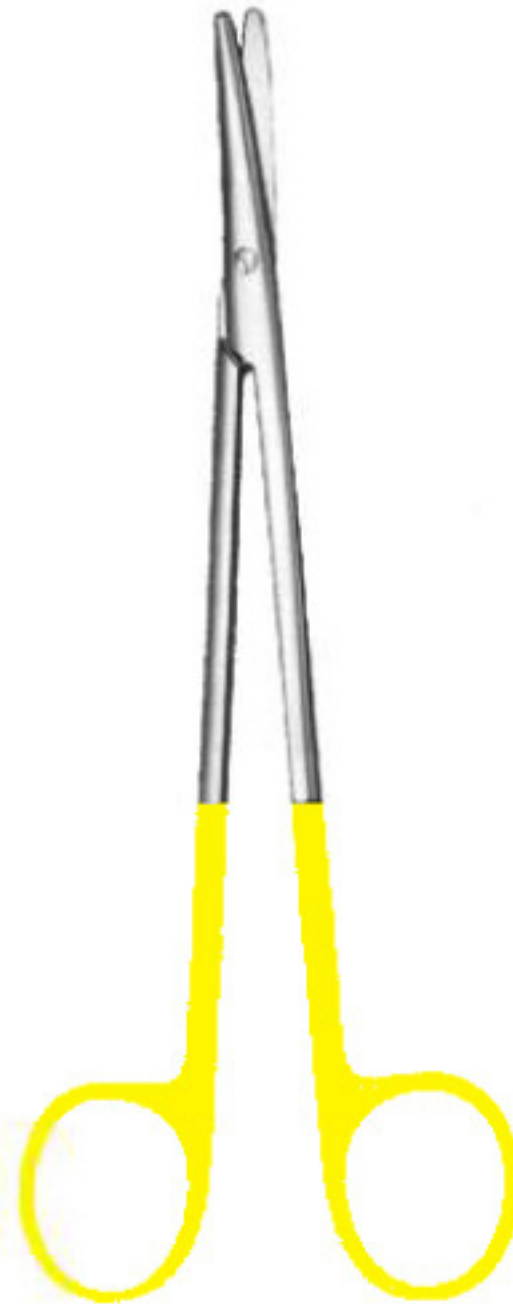

**3208**

**METZENBAUM**  
Straight  
145mm (5.3/4")  
180mm (7")  
200mm (8")

Curved  
145mm (5.3/4")  
180mm (7")

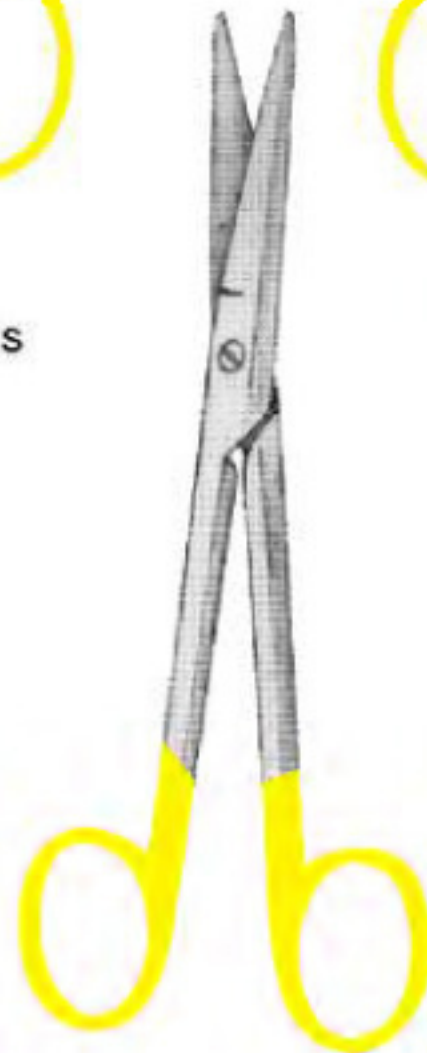

**3209**

**MAYO**  
140mm (5.1/2")

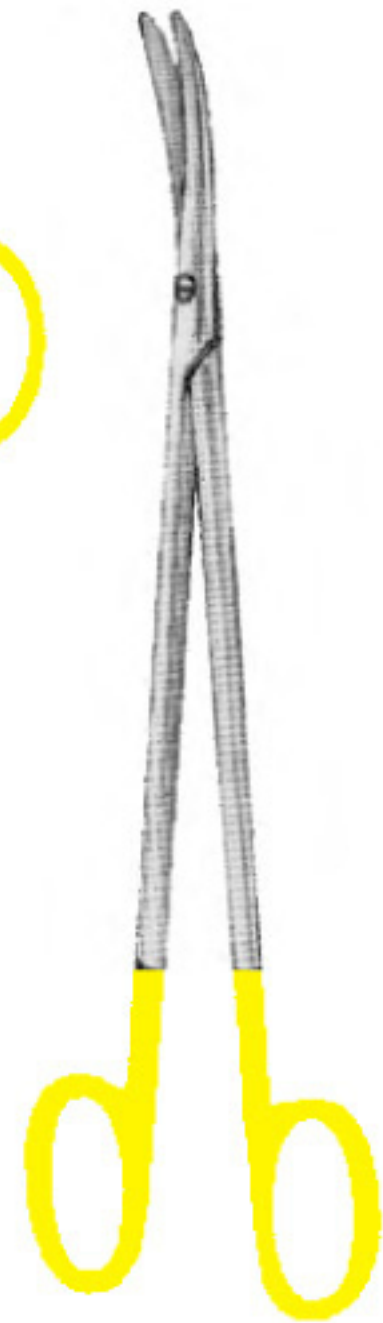

**3210**

**McIndoe**  
190mm (7.1/4")





# "TC" DISSECTING FORCEPS

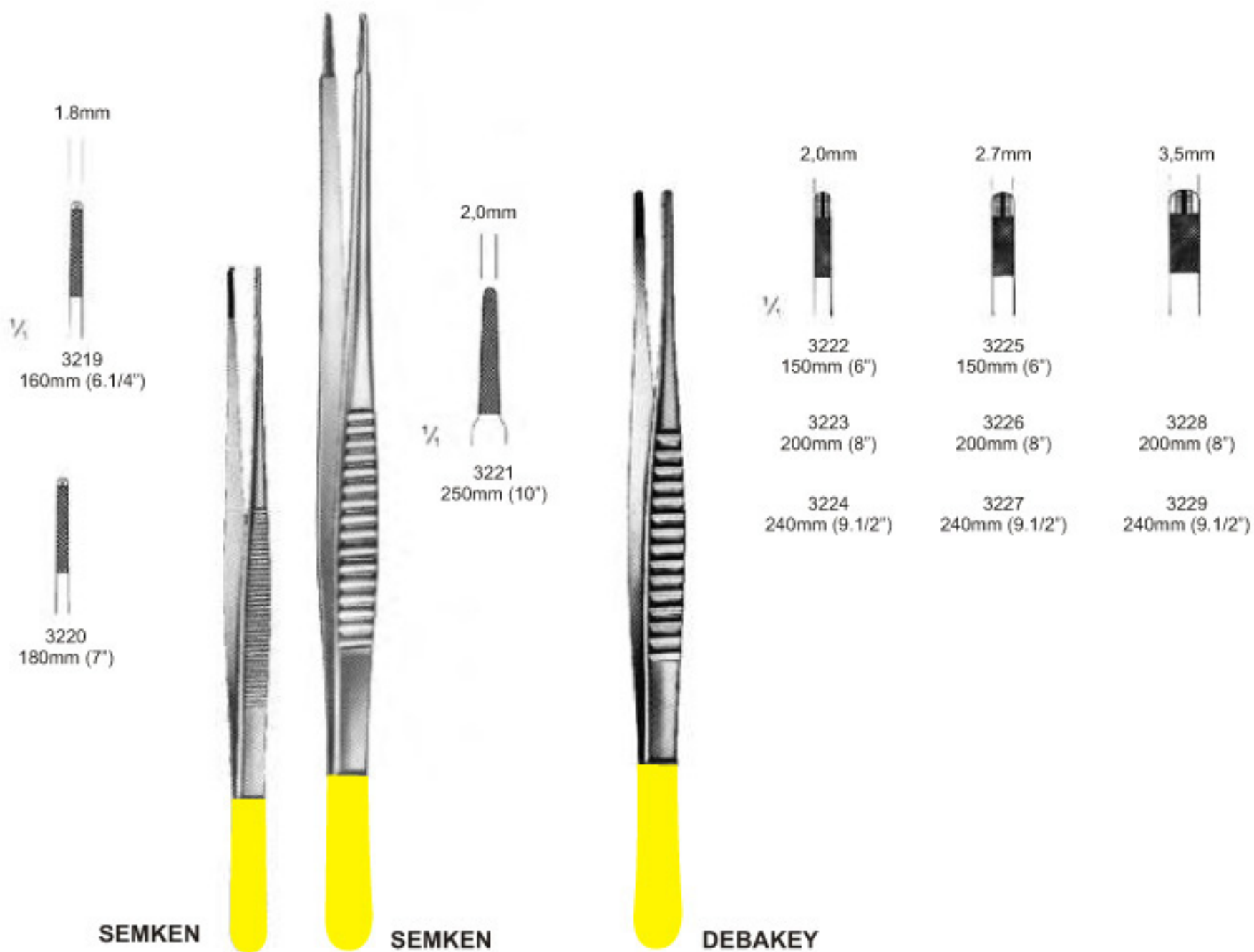
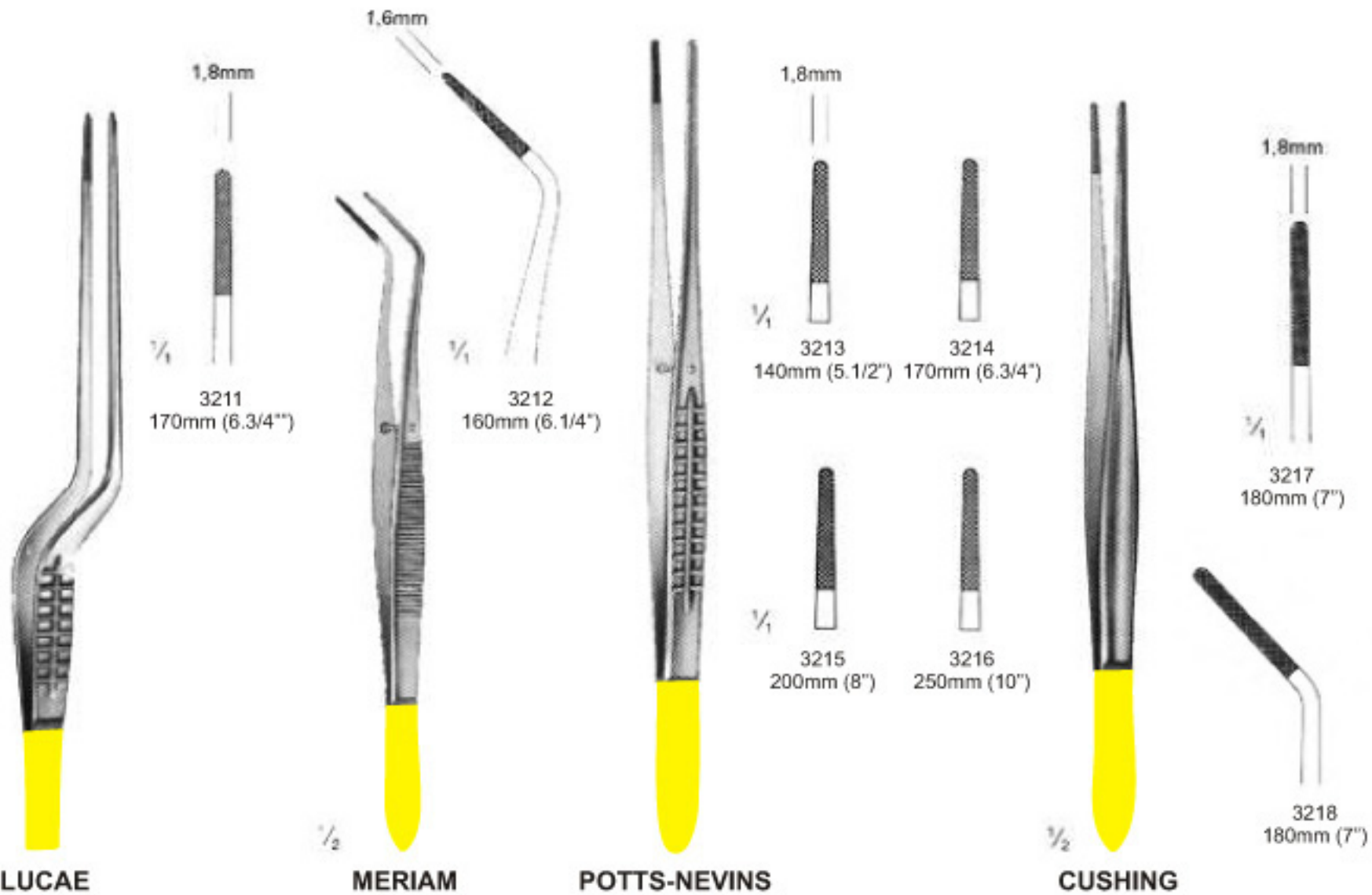



**3230**  
230mm (9")



**3231**  
185mm (7.1/4")

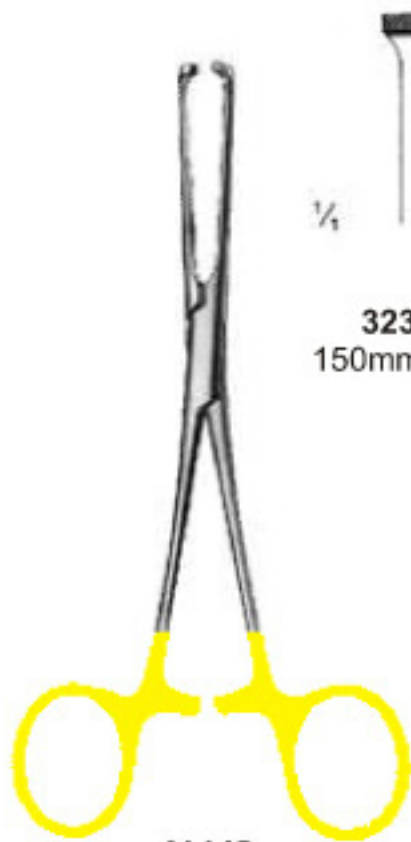

**ALLIS**

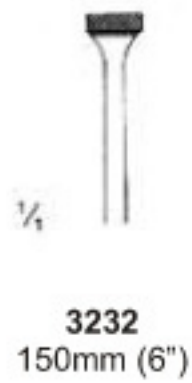

**3232**  
150mm (6")



**3233**  
190mm (7.1/2")

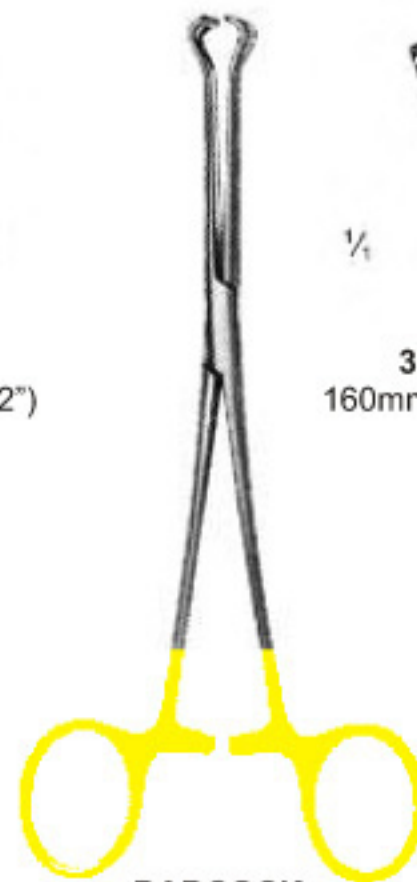

**BABCOCK**

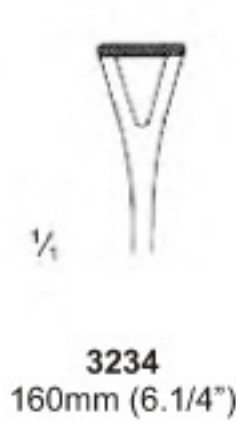

**3234**  
160mm (6.1/4")



**3235**  
200mm (8")

# "TC" DISSECTING FORCEPS



**3236**  
145mm  
(5.3/4")



**3237**  
180mm  
(7")



**3238**  
200mm  
(8")



**3239**  
250mm  
(10")



**WANGENSTEEN**



**3240**  
150mm  
(6")



**3241**  
230mm  
(9")







**ADSON**  
**3242**  
120mm (4.3/4")

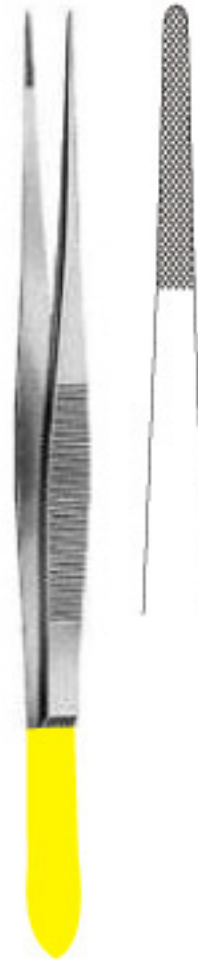

**CUSHING**  
**3243**  
180mm (7")  
With scraper end



**3244**  
145mm  
(5.3/4")



**3245**  
200mm  
(8")



**3246**  
250mm  
(10")



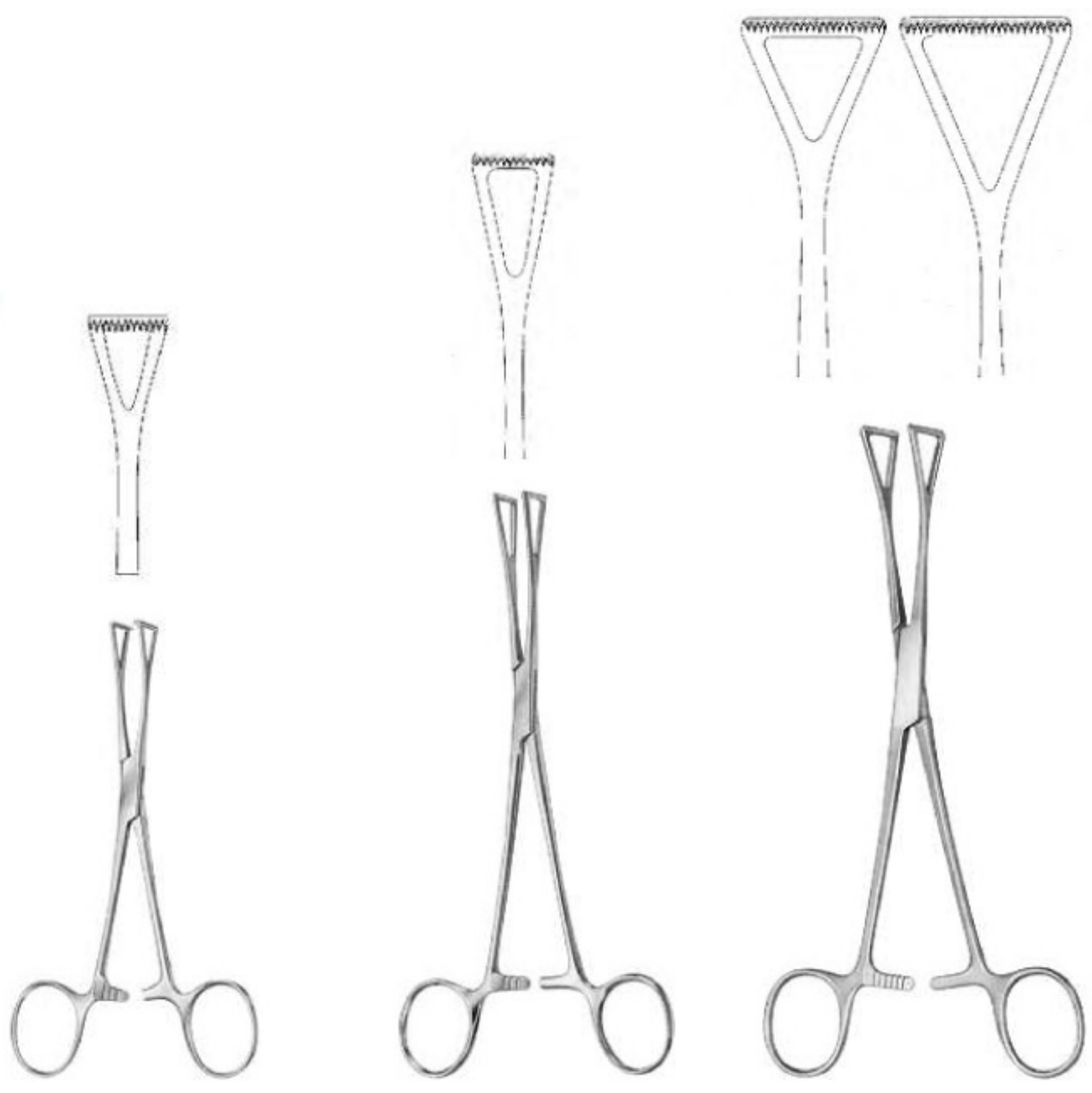

**DUVAL**  
**3247**  
140mm (5.1/2")

**DUVAL**  
**3248**  
180mm (7")

**DUVAL**  
**3249**  
190mm (7.1/2")  
**3250**  
200mm (8")





**RUTHERFORD MORISON**

**3251**  
150mm (6")  
6 x 7 teeth



**STILES (ALLIS-THOMS)**

**3252**  
200mm (8")  
6 x 7 teeth



**LANE**  
1 x 2 teeth fenestrated

**3253**  
125mm (5")

**3254**  
150mm (6")





# DISSECTING & LIGATURE FORCEPS



**3255**  
215mm (8.1/2")



**3256**  
210mm (8.1/4")



**3257**  
220mm (8.3/4")



**3258**  
225mm (9")



**3259**  
225mm (9")



**FINE CURVED DISSECTING  
FORCEPS**



**3260**  
295mm (11.3/4")



**3261**  
295mm (11.3/4")



**3262**  
300mm (12")





**LIGATURE FORCEPS**  
**3263**  
95mm (3.3/4")  
Straight, smooth jaw



**MICRO ADSON**  
**3264**  
140mm (5.1/2")

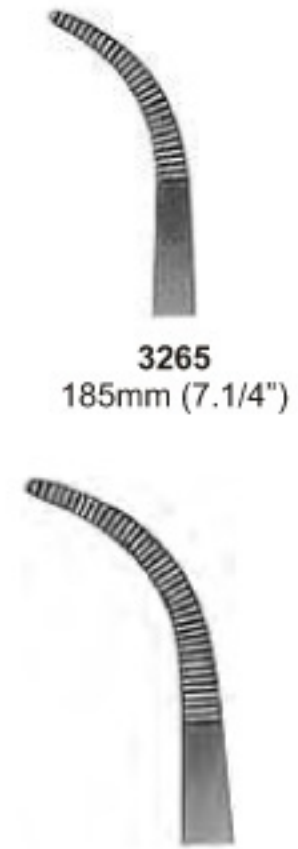

**3265**  
185mm (7.1/4")

**3266**  
210mm (8.1/4")



**BABY - ADSON**



**3267**  
140mm  
(5.1/2")



**3268**  
180mm  
(7")



**S.SHAPED DELICATE**

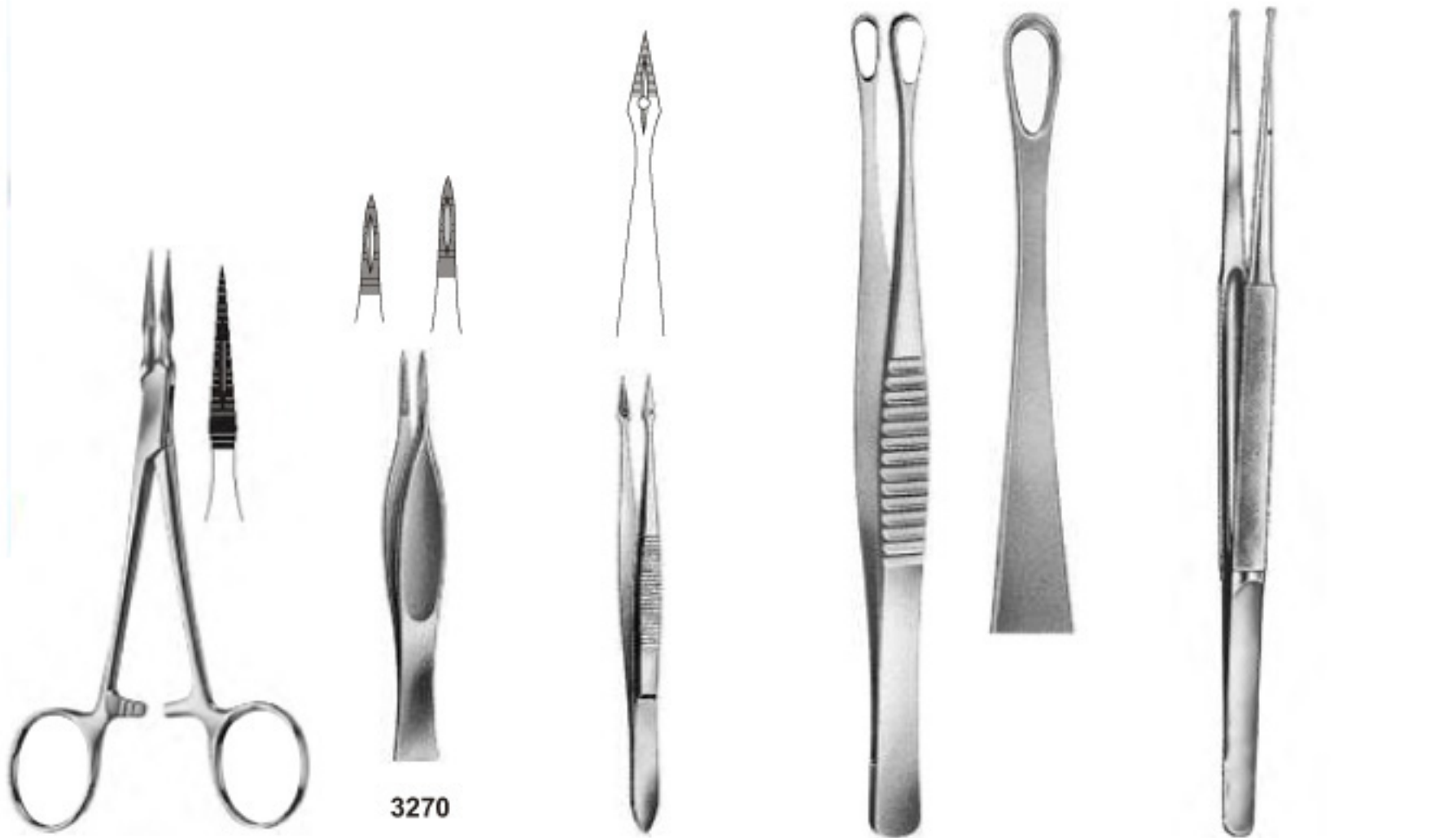

**3269**  
**ARTHURE**  
140mm (5.1/2")

**FEILCHENFEL**  
70mm (3")  
90mm (3.1/2")  
115mm (4.1/2")

**3271**  
**HUNTER**  
105mm (4.1/8")

**DENIS BROWNE**  
**3272**  
190mm (7.1/2")

**MICRO SOFT TOUCH RING TIP**  
**3273** 150mm (6")  
**3274** 185mm (7.1/4")  
**3275** 210mm (8.1/4")  
**3276** 230mm (9")  
**3277** 250mm (10")



**TROELTSCH (Wilde)**  
**3278**  
110mm (4.1/2")

**TROELTSCH (Wilde)**  
**3279**  
120mm (4.3/4")  
1 x 2 teeth



**TUDICHUM**  
**3280**  
65mm (2.3/2")

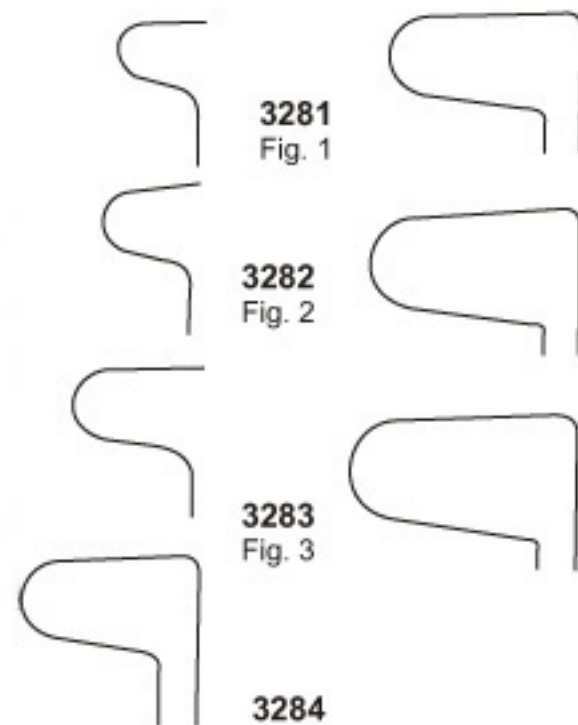

**3281**  
Fig. 1

**3282**  
Fig. 2

**3283**  
Fig. 3

**3284**  
Fig. 4





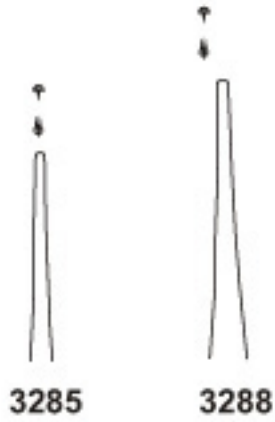

**SILCOCK**  
1 x 2 teeth  
  
**3286**  
100mm (4")  
**3287**  
110mm (4.3/8")

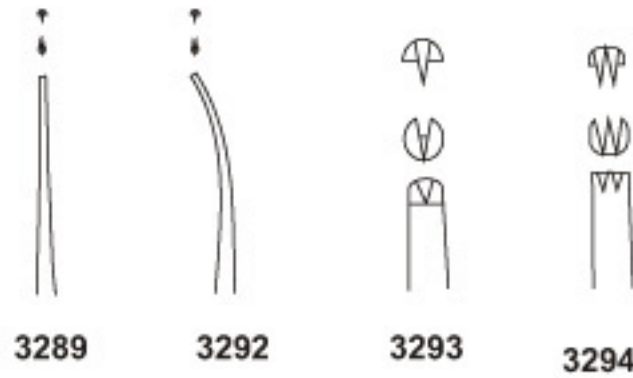

**FINE**  
1 x 2 teeth  
**3290**  
100mm (4")  
**3291**  
100mm (4")



**RAMSEY**  
180mm (7")



**BONNEY**  
1 x 2 teeth  
  
**3295**  
180mm (7")



**BICKFORD**  
1 x 2 teeth  
  
**3296**  
225mm (9")



**CANADIAN**  
2 x 3 teeth  
  
**3297**  
140mm (5.1/2")  
  
**3298**  
150mm (6")

# TOOTHED DISSECTING FORCEPS



**WAUGH**  
1 x 2 teeth

**3299**  
200mm (8")

**3300**  
180mm (7")

**3301**  
150mm (6")



**ADSON**  
1 X 2 teeth

**3302**  
125mm (5") Fine

**3303**  
125mm (5") Standard

**3304**  
190mm (7.1/2")



**ADSON**  
Bayonet  
1 x 2 teeth

**3305**  
190mm (7.1/2")



**JEFFERSON**  
1 x 2 teeth

**3306**  
180mm (7")



**ADSON-BROWN**  
7 x 7 teeth

**3307**  
125mm (5")



**PENNYBACKER**  
3 x 4 teeth

**3308**  
160mm (6.1/2")



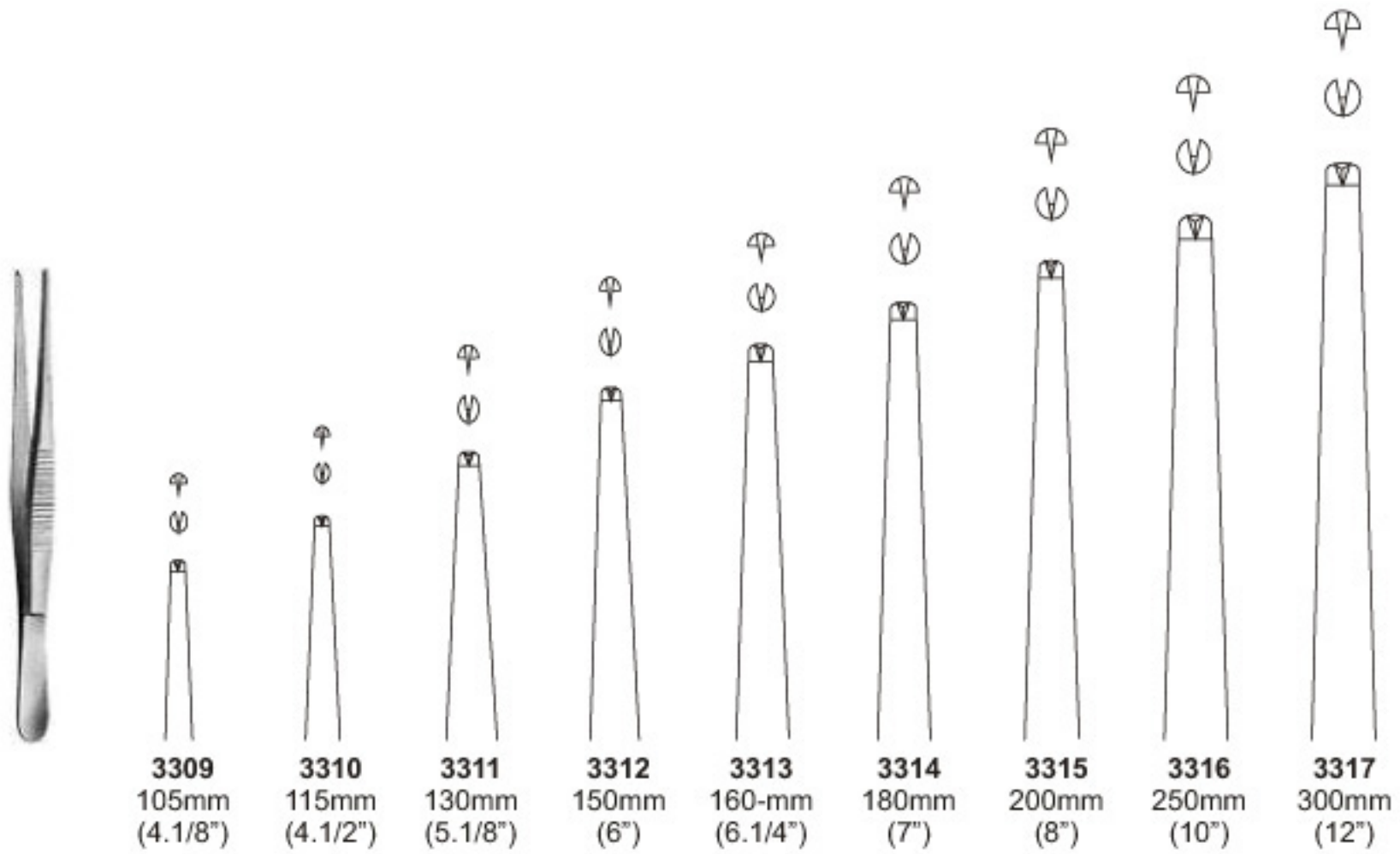

## DISSECTING FORCEPS

1 x 2 teeth

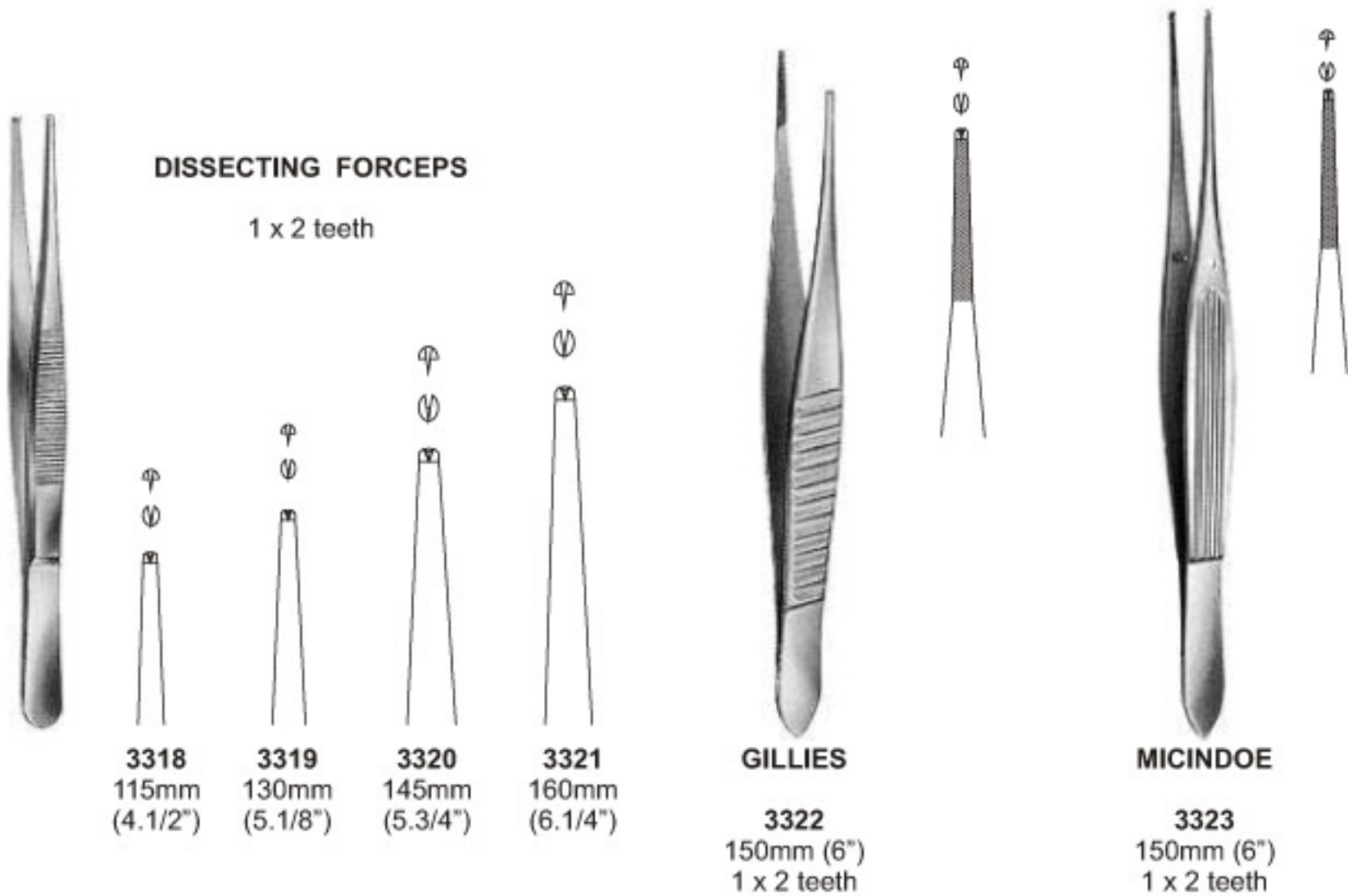



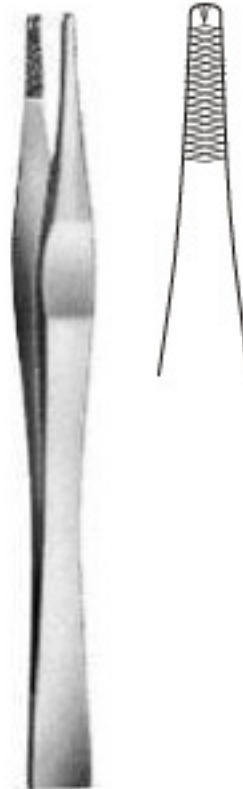

**LANE**  
1 x 2 teeth

**3329**  
125 mm (5")

**3330**  
145mm (5.3/4")

**3331**  
180mm (7")

**LANE**  
2 x 3 teeth  
**3332**  
145mm (5.3/4")

**3333**  
180mm (7")



**DISSECTING FORCEPS**

**3334**  
150mm (6")  
2 x 3 teeth

**3335**  
150mm (6")  
3 x 4 teeth



**TREVES**  
1 x 2 teeth

**3324**  
125mm (5")

**3325**  
150mm (6")

**3326**  
180mm (7")

**3327**  
200mm (8")

**3328**  
250mm (10")





**ADSON**

- 3336**  
125mm (5") Fine
- 3337**  
125mm (5") Standard
- 3338**  
190mm (7.1/2")



**CAIRNS (DOTT)**

- 3339**  
215mm (8.1/2")  
Medium jaw  
2mm wide
- 3340**  
180mm (7")  
Fine jaw  
1mm wide



**JEFFERSON**

- 3341**  
180mm (7")



**SILCOCK**

- 3342**  
100mm (4")



**EXTRA FINE**  
100mm (4")



**3343**



**3344**

# DELICATE DISECTING FORCEPS



**3345**  
90mm  
(3.1/2")



**3346**  
105mm  
(4.1/8")



**3347**  
115mm  
(4.1/2")



**3348**  
130mm  
(5.1/8")



**3349**  
145mm  
(5.3/4")



**3350**  
90mm  
(3.1/2")



**3351**  
105mm  
(4.1/8")



**3352**  
115mm  
(4.1/2")



**3353**  
130mm  
(5.1/8")

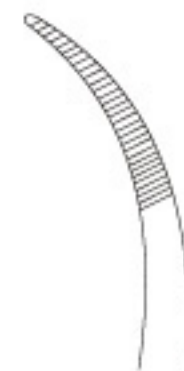

**3354**  
145mm  
(5.3/4")



**MACINDOE**  
**3355**  
150mm (6")



**WAUGH**  
**3356**  
200mm (8")



**WAUGH**



**3357**  
150mm (6")

**3358**  
180mm (7")







**MAINGOT INTESTINAL**  
Fenestrated Grip

**3359**  
280mm (11")



**ST MARKS**  
**3360**  
290mm (11.1/2")



**EMMET**  
**3361**  
200mm (8")



# SERRATED DISSECTING FORCEPS



**BONNEY**  
3363  
180mm (7")



**RAMSEY**  
3362  
180mm (7")



**BICKFORD**  
3364  
225mm (9")





**DISSECTING  
FORCEPS**



**3365**  
115mm  
(4.1/2")



**3366**  
130mm  
(5.1/8")



**3367**  
145mm  
(5.3/4")



**3368**  
160mm  
(6.1/4")



**3369**  
305mm  
(12")



**DISSECTING  
FORCEPS**



**3370**  
150mm  
(6")



**3371**  
180mm  
(7")



**3372**  
200mm  
(8")





# SERRATED DISSECTING FORCEPS



## DISSECTING FORCEPS Turn over end

**3375**  
125mm (5")

**3376**  
150mm (6")

**3377**  
180mm (7")

**3378**  
200mm (8")

**3379**  
250mm (10")



## CANADIAN Straight

**3373**  
130mm (5.1/8")

**3374**  
150mm (6")



## DISSECTING FORCEPS Block end

**3380**  
125mm (5")

**3381**  
150mm (6")

**3382**  
180mm (7")

**3383**  
200mm (8")

**3384**  
250mm (10")





**LITTLEWOOD**

**3385**  
185mm (7.1/4")  
2 x 3 teeth



**TUBING CLAMP**

**3386**  
175mm (7")

**3387**  
200mm (8")





**CHAPUT (POIRIER)**

**3389**  
125mm (5")  
2 x 3 teeth

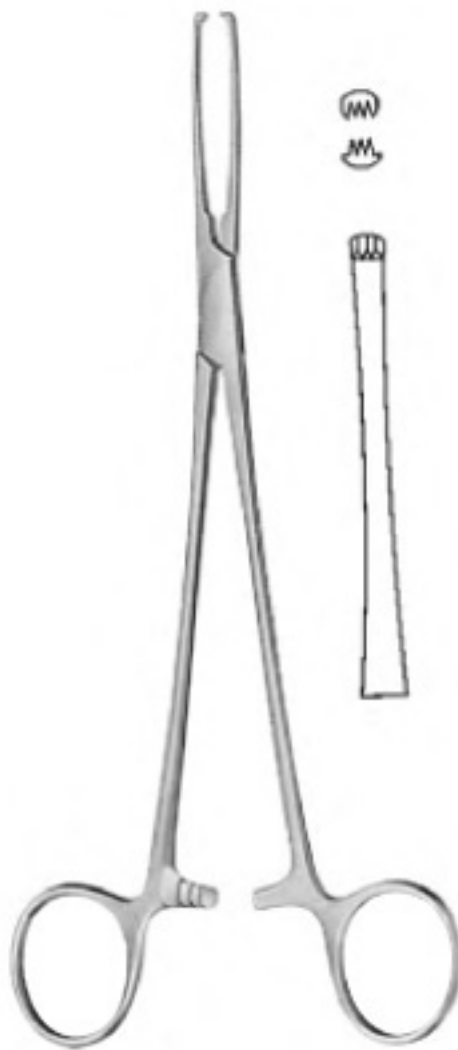

**JUD-ALLIS**

**3388**  
195mm (7.3/4")  
Light pattern, 3 x 4 teeth



**LITTLEWOOD**

**3390**  
185mm (7.1/4")  
2 x 3 teeth







**JUD-ALLIS**

**3391**  
195mm (7.3/4")  
Light pattern, 3 x 4 teeth



**CHAPUT (POIRIER)**

**3392**  
125mm (5")  
2 x 3 teeth





**ALLIS**  
150mm (6")

**3393**  
2 x 3 teeth

**3394**  
3 x 4 teeth

**3395**  
4 x 5 teeth

**3396**  
5 x 6 teeth

**3397**  
6 x 7 teeth



**3401**



**3402**



**AMERICAN PATTERN ALLIS**

**3398**  
150mm (6")  
3 x 4 teeth



**ALLIS**

**3399**  
190mm (7.1/2")

**3400**  
255mm (10")  
5 x 6 Teeth





**3403**  
125mm  
(5")



**3404**  
150mm  
(6")



**3405**  
180mm  
(7")



**3406**  
200mm  
(8")



**3407**  
225mm  
(9")



**SPENCER WELLS**  
Straight



**3408**  
125mm  
(5")



**3409**  
150mm  
(6")



**3410**  
180mm  
(7")



**3411**  
200mm  
(8")



**3412**  
225mm  
(9")

**SPENCER WELLS**  
Curved on flat







**FRASER-KELLY (CRILE)**

**3413**  
180mm (7")  
Curved on flat



**3414**  
180mm (7")  
Curved on flat



**3415**  
180mm (7")  
Straight



**3416**  
185mm (7.1/4")  
Curved on flat  
1 x 2 teeth



**3417**  
185mm (7.1/4")  
Straight  
1 x 2 teeth



**FRASER - ADSON**



**DUNHILL**

**3418**  
125mm (5")  
Curved on flat

**3419**  
125mm (5")  
Straight

**3420**  
180mm (7")  
Curved on flat





**KOCHER**  
Curved on flat 1 x 2 teeth

**3421**  
125mm (5")

**3422**  
140mm (5.1/2")

**3423**  
150mm (6")

**3424**  
180mm (7")

**3425**  
200mm (8")

**3426**  
225 (9")



**LLOYD DAVIS**

**3427**  
260mm (10.1/4")  
Curved on flat



**MAYO**

**3428**  
160mm (6.1/4")  
Curved on flat





**KELLY**  
Curved on flat

**3429**  
140mm (5.1/2")

**3430**  
160mm (6.1/4")



**KOCHER**  
Straight 1 x 2 teeth

**3431**  
125mm (5")

**3432**  
140mm (5.1/2")

**3433**  
150mm (6")

**3434**  
180mm (7")

**3435**  
200mm (8")

**3436**  
225mm (9")



**KELLY HALSTEAD**

**3437**  
140mm (5.1/2")  
Straight

**3438**  
140mm (5.1/2")  
Curved on flat





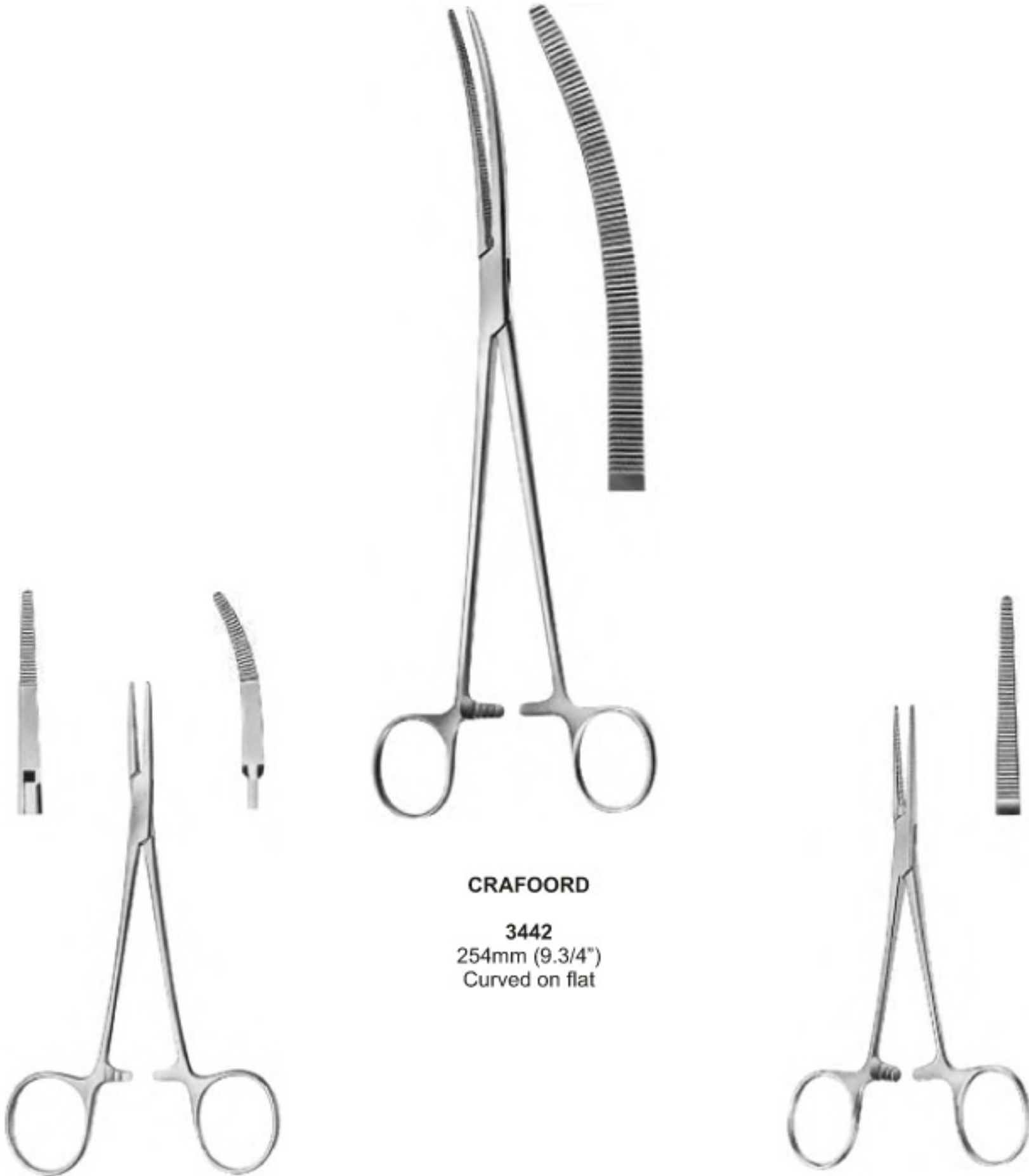

### CRAFOORD

**3442**  
254mm (9.3/4")  
Curved on flat

### CAIRNS

**3439**  
145mm (5.3/4")

**3440**  
145mm (5.3/4")  
Curved on flat

**3441**  
145mm (5.3/4")  
Curved to side

### CRILE

Straight

**3443**  
140mm (5.1/2")

**3444**  
160mm (6.1/4")

**3445**  
180mm (7")





**BABY-CRILE**

**3446**  
140mm (5.1/2")  
Curved on flat



**BABY-CRILE**

**3447**  
140mm (5.1/2")  
Straight  
1 x 2 teeth



**BABY CRILE**

**3448**  
140mm (5.1/2")  
Curved on flat  
1 x 2 teeth



**HALSTEAD MOSQUITO**  
125mm (5")

**3449**  
Straight

**3450**  
Curved on flat

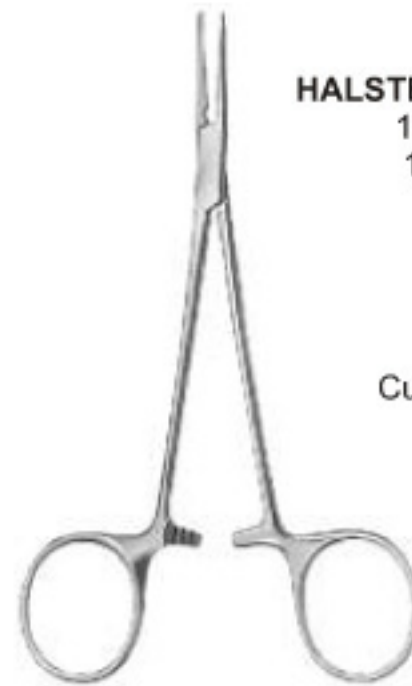

**HALSTEAD MOSQUITO**  
125mm (5")  
1 x 2 teeth

**3451**  
Straight

**3452**  
Curved on flat





**HALSTEAD MOSQUITO**

**3453**  
100mm (4")  
Straight



**HALSTEAD MOSQUITO**

**3454**  
100mm (4")  
Curved on flat



**HALSTEAD MOSQUITO**

100mm (4")  
1 x 2 teeth

**3455**  
Straight

**3456**  
Curved on flat



**HALSTEAD MOSQUITO**

125mm (5")

**3457**  
Straight

**3458**  
Curved on flat



**HALSTEAD MOSQUITO**

125mm (5")  
1 x 2 teeth

**3459**  
Straight

**3460**  
Curved on flat



**BABY - CRILE**

**3461**  
140mm (5.1/2")  
Straight







**BOZEMANN**  
**3462**  
250mm (10")  
S-shaped curve



**BOZEMANN**  
**3463**  
260mm (10.1/4")  
Straight



**3464**  
250mm (10")  
Curved





**RAMPLEY**

**3465**  
180mm (7")

**3466**  
240mm (9.1/2")



**FORESTER**

**3467**  
240mm (9.1/2")

**3468**  
180mm (7")  
Straight

**3469**  
240mm (9.1/2")

**3470**  
180mm (7")  
Curved on flat



**3471**



**3472**

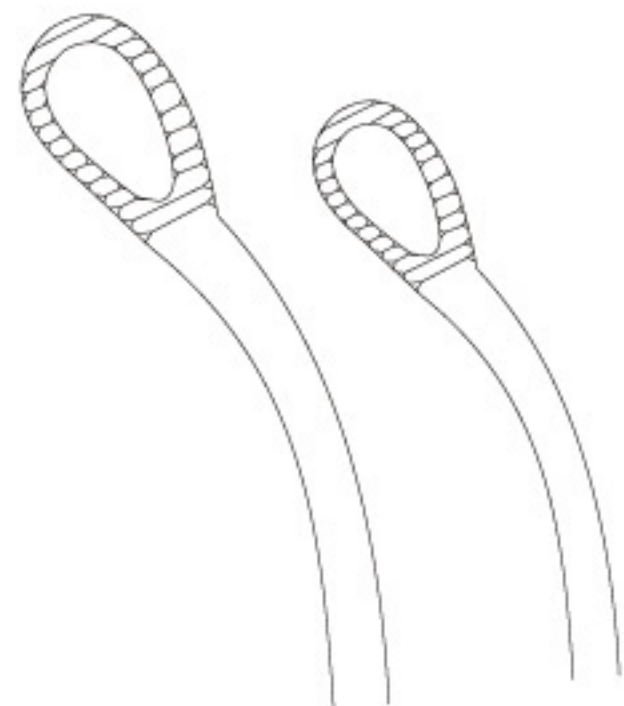

**3473**

**3474**



**BALL AND SOCKET**

**3475**  
130mm (5")



**BACKHAUS**

**3476**  
90mm (3.1/2")



**3477**  
100mm (4.3/4")



**3478**  
135mm (5.1/4")

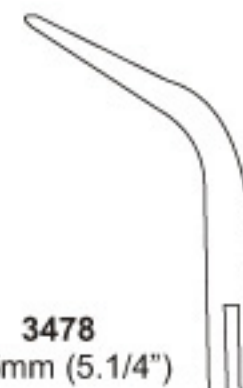

**MAYO**

**3479**  
140mm (5.1/2")



**MOYNIHAN**

**3480**  
190mm (7.1/2")  
2 x 2 teeth







**3483**



**3484**



**COLLIN TONGUE FORCEPS**

**3481**  
170mm (6.3/4")

**3482**  
160mm (6.1/4")



**HEYWOOD-SMITH TONGUE FORCEPS**

**3485**  
200mm (8")



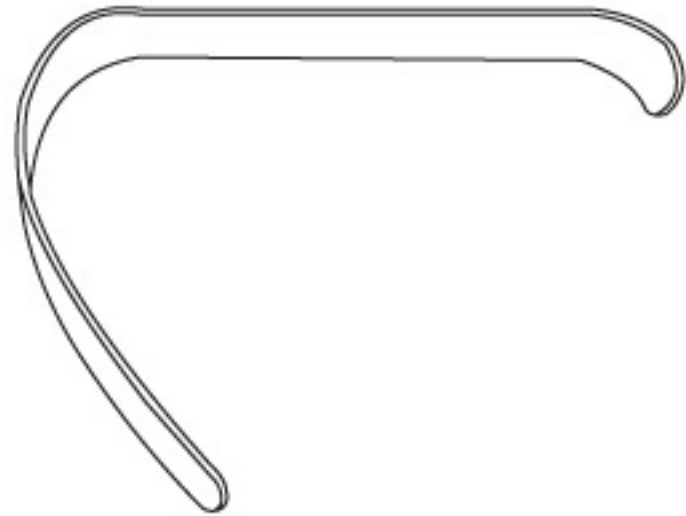

**LACK TONGUE DEPRESSOR**

**3486**  
13mm wide  
child

**3487**  
19mm wide  
Adolescent

**3488**  
22mm wide  
Adults



**3489**  
180mm (7")

**FLAT TONGUE DEPRESSOR**

Double ended  
tapering 19mm + 23mm



**3490**  
140mm (5.1/2")





**WEBSTER**  
Smooth Jaw

**3491**  
115mm (4.1/2")



**LAWRANCE**

**3492**  
150mm (6")  
Lightweight

**3493**  
150mm (6")



**MAYO**

**3494**  
150mm (6")



**MCPHAILS**

**3495**  
180mm (7")







**HALSEY**  
**3496**  
125mm (5")



**MATHIEU**  
**3497**  
140mm (5.1/2")



**MATHIEU**  
**3498**  
170mm (6.3/4")



**MATHIEU**  
**3499**  
200mm (8")





**MAYO (BAUMGARTNER)**



**3500**  
140mm (5.1/2")

**MAYO (MASSON)**



**3501**  
265mm (10.1/2")

**MAYO**



**3502**  
165mm (6.1/2")



**3503**  
190mm (7.1/2")



**3504**  
200mm (8")



**3505**  
230mm (9")



**HEGAR**

**3506**  
200mm (8")



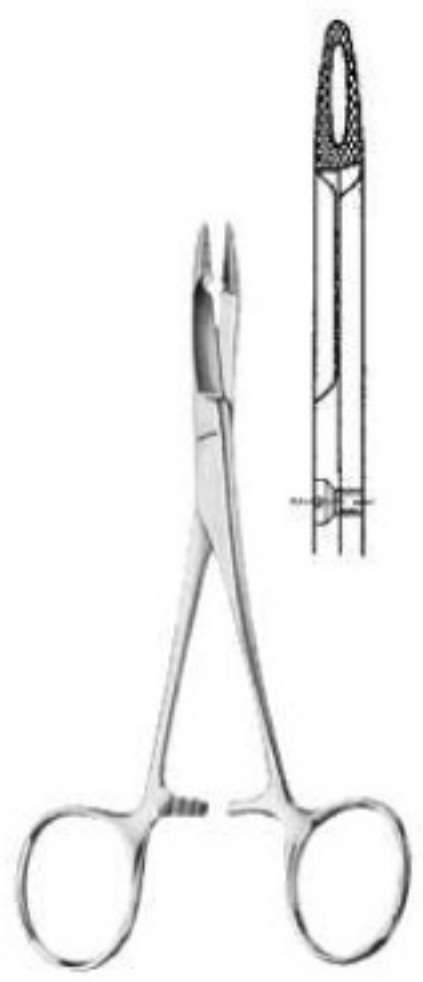

**OLSEN HEGAR**  
Combined needle holder  
and scissors

**3507**  
140mm (5.1/2")

**3508**  
165mm (6.1/2")

**3509**  
190mm (7.1/2")



**WARD**  
Combined needle holder  
and scissors

**3510**  
180mm (7")







**JAMESON**

**3511**  
230mm (9")



**WRIGHT**

**3512**  
125mm (5")



**GILLIES**  
Combined needle holder  
and scissors

**3513**  
160mm (6.1/4")



**KILNER**

**3514**  
135mm (5.1/4")



**HEANEY**

**3515**  
200mm (8")





**CRILE WOOD**

**3516**  
150mm (6")



**CRILE MURRAY**

**3517**  
145mm (5.3/4")



**WANGENSTEEN**

**3520**  
270mm (10.3/4")



**NAUNTON MORGAN**

**3518**  
190mm (7.1/2")

**3519**  
250mm (10")





**CONVERSE**

**3521**  
125mm (5")



**DERF**

**3522**  
120mm (4.3/4")



**MAYO (DUNHILL)**

**3523**  
160mm (6.1/4")



**MAYO**

**3524**  
180mm (7")



**MAYO**

**3525**  
190mm (7.1/2")





**LITTLEWOOD**  
**3526**  
185mm (7.1/4")  
2 x 3 teeth



**TUBING CLAMP**  
**3527**  
175mm (7")  
**3528**  
200mm (8")





**CASTROVIEJO**

**3529**  
145mm (5.3/4")  
With catch



**CASTROVIEJO**

**3530**  
145mm (5.3/4")  
With catch



**ARRUGA**

**3531**  
135mm (5.1/4")



**BARRAQUER**

**3532**  
120mm (4.3/4")  
With catch



**BARRAQUER**

**3533**  
120mm (4.3/4")  
Without catch



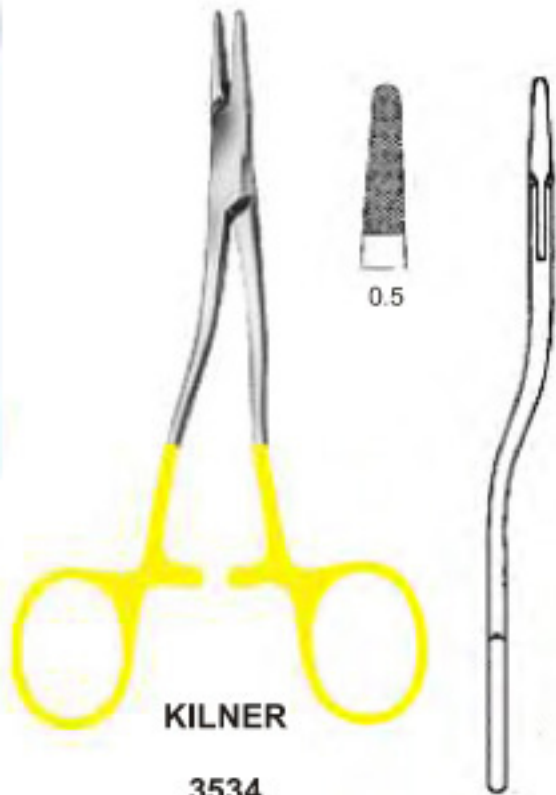

**KILNER**  
**3534**  
135mm (5.1/4")

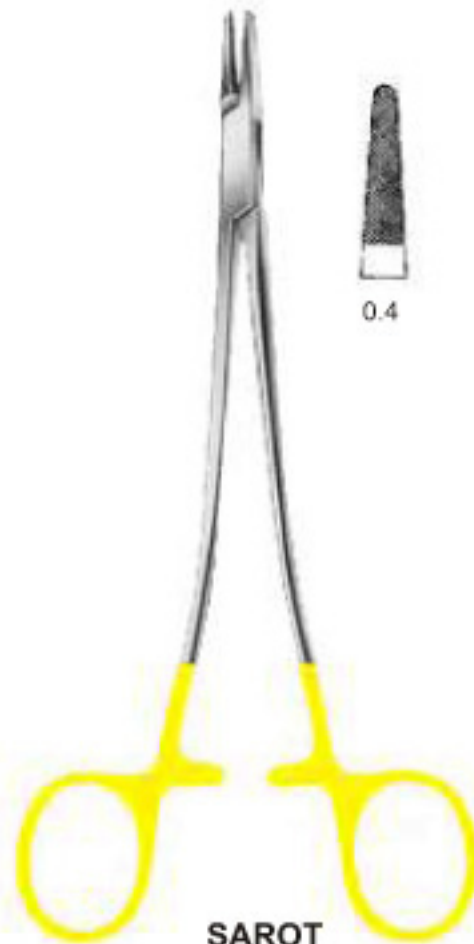

**SAROT**  
**3535**  
175mm (7")

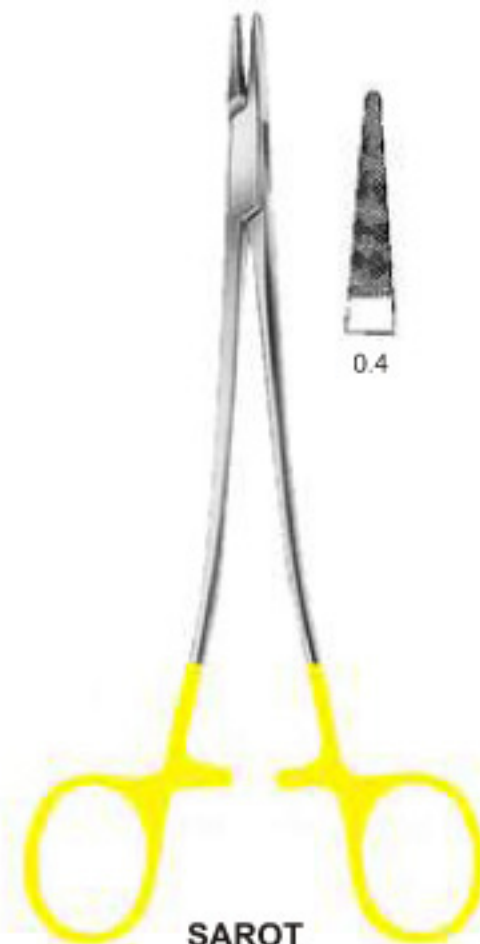

**SAROT**  
**3536**  
260mm (10.1/4")

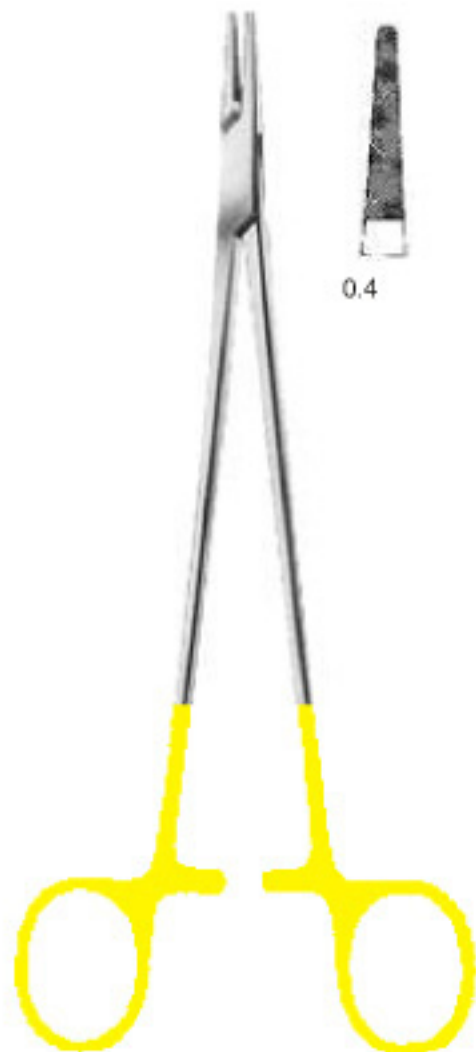

**HAGAR-MAYO**  
**3537**  
200mm (8")

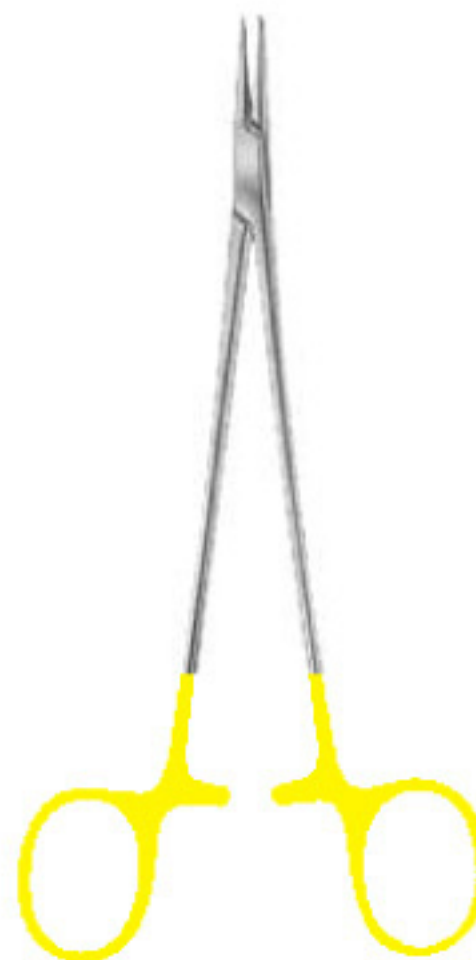

Very Delicate

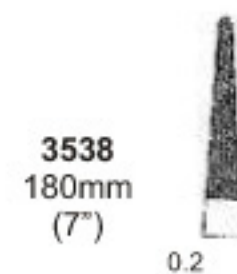

**3538**  
180mm  
(7")



**3539**  
200mm  
(8")

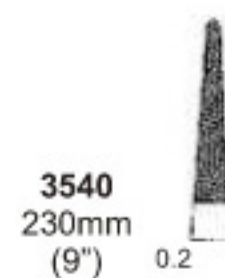

**3540**  
230mm  
(9")





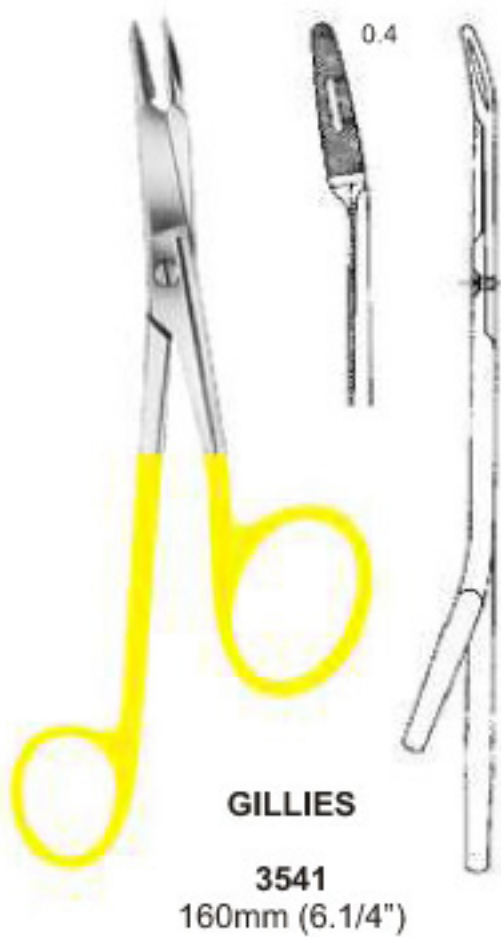

**3543**  
210mm (8.1/4")

**3544**  
165mm (6.1/2")

**3545**  
210mm (8.1/4")

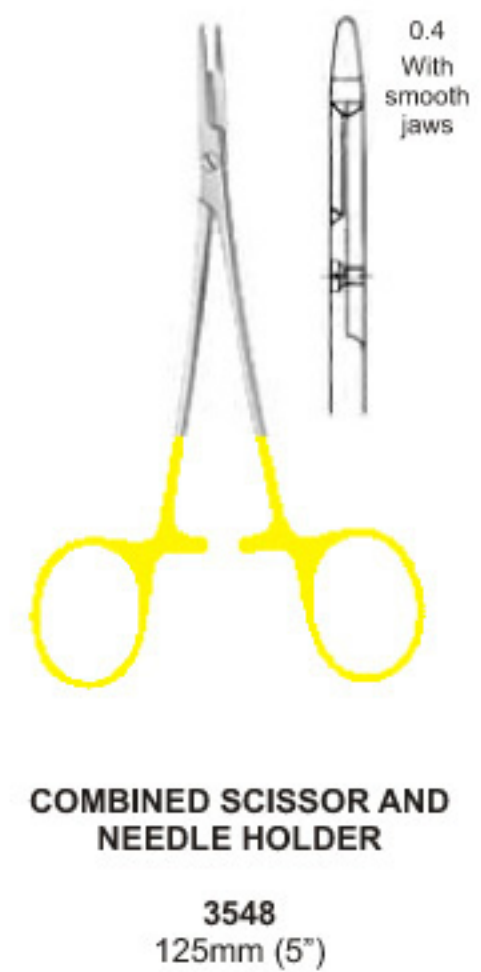



# "TC" NEEDLE HOLDERS



0.5

**3549**  
195mm (7.3/4")  
Elastic pattern, delicate



0.5

**3550**  
200mm (8")



0.5

**HOESEL**  
**3554**  
260mm (10.1/4")  
With long neck



**MATHIEU-STANDARD**



0.5

**3551**  
140mm (5.1/2")



0.5

**3552**  
170mm (6.3/4")



0.5

**3553**  
200mm (8")





**ZWEIFEL**



0.5

**3555**  
200mm (8")  
Heavy pattern for  
sternum suture



**MATHIEU**  
Heavy pattern



0.5

**3556**  
200mm (8")



0.5

**3557**  
245mm (9.3/4")



0.4

**3558**  
200mm (8")



0.4

**3559**  
260mm (10.1/4")

With long neck



**ZWEIFEL**



0.5

**3560**  
180mm (7")



0.5

**3561**  
230mm (9")







# "TC" NEEDLE HOLDERS



**3562**  
200mm (8")

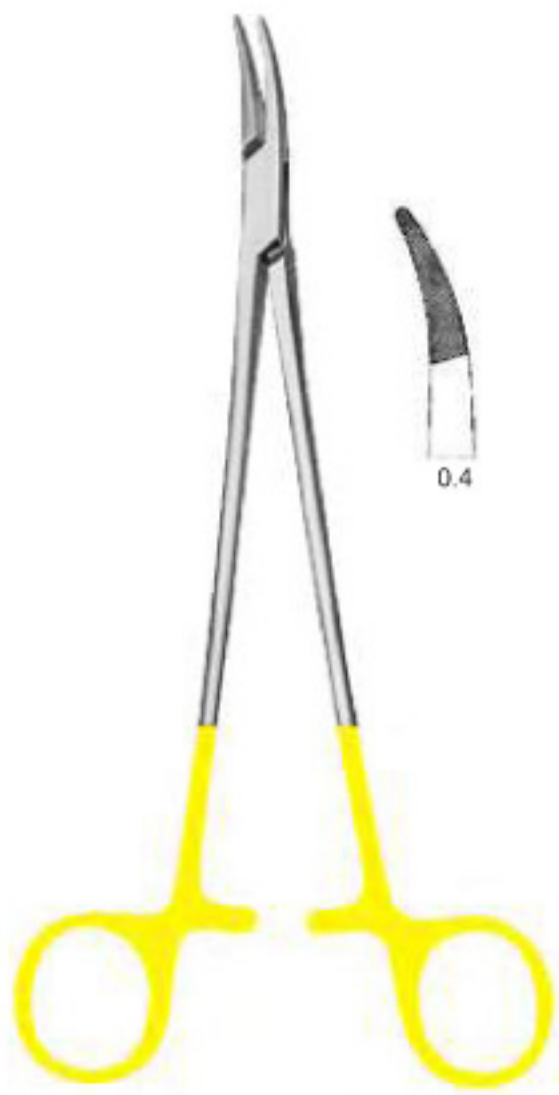

**JULIAN**  
**3563**  
200mm (8")



**TOENNIS**  
**3564**  
185mm (7.1/4")



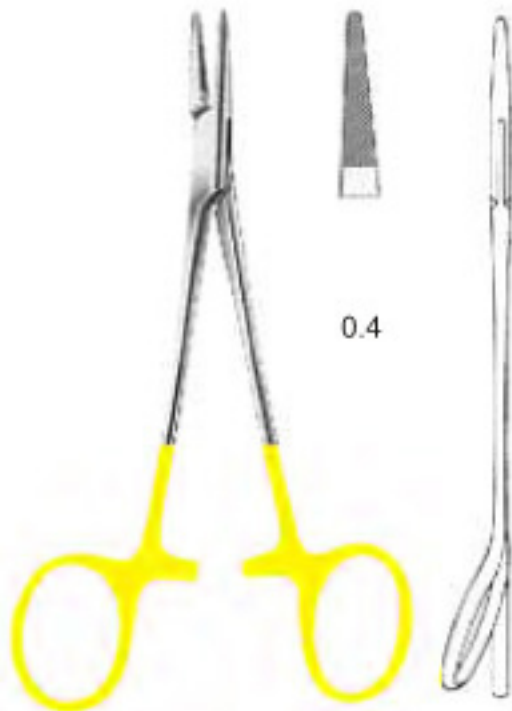

**MASING**  
**3565**  
130mm (5.1/8")  
One ring angled

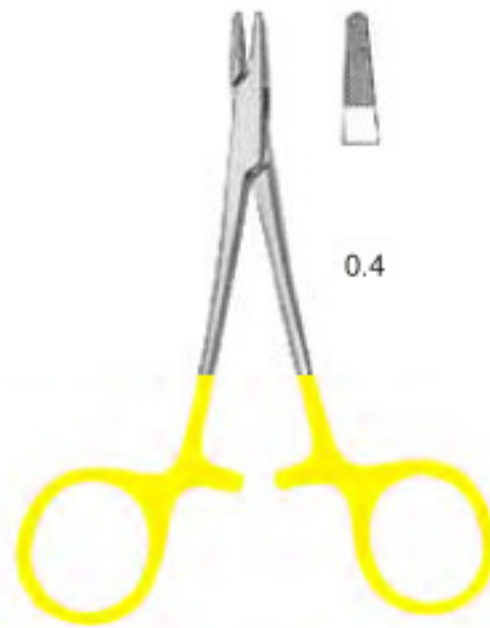

**DERF**  
**3566**  
115mm (4.1/2")

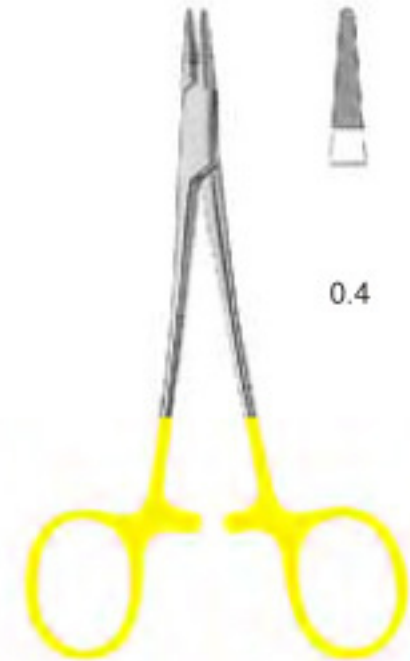

**MASING**  
**3567**  
125mm (5")



**CRILE - WOOD**



**3568**  
180mm  
(7")



**3569**  
200mm  
(8")

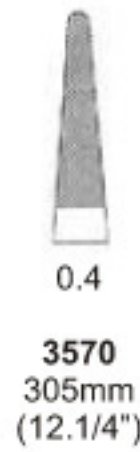

**3570**  
305mm  
(12.1/4")

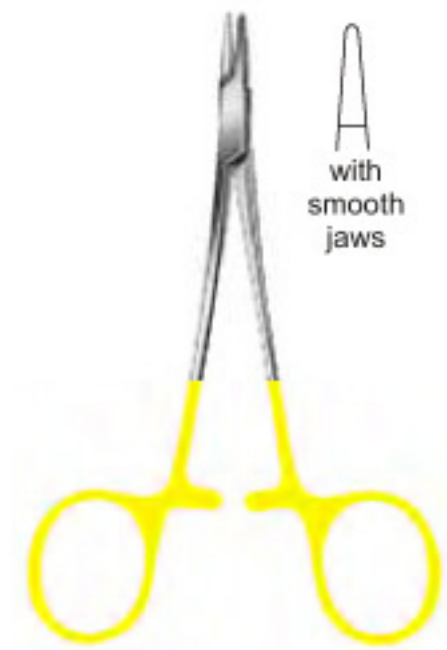

**HALSEY**  
**3571**  
120mm (4.3/4")



# "TC" NEEDLE HOLDERS

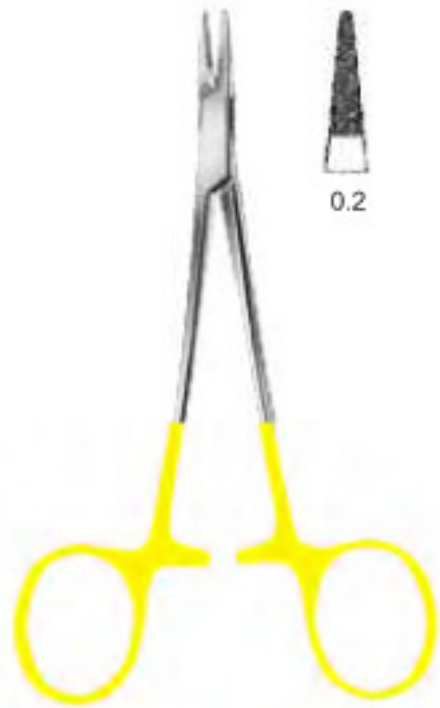

**CONVERSE**

**3572**  
130mm (5.1/8")

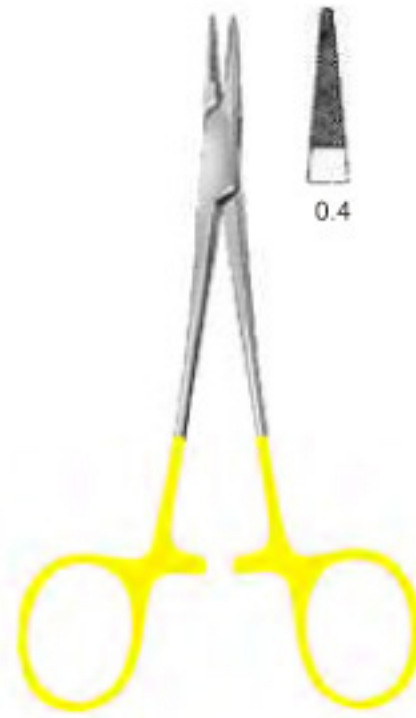

**HALSEY**

**3573**  
130mm (5.1/8")

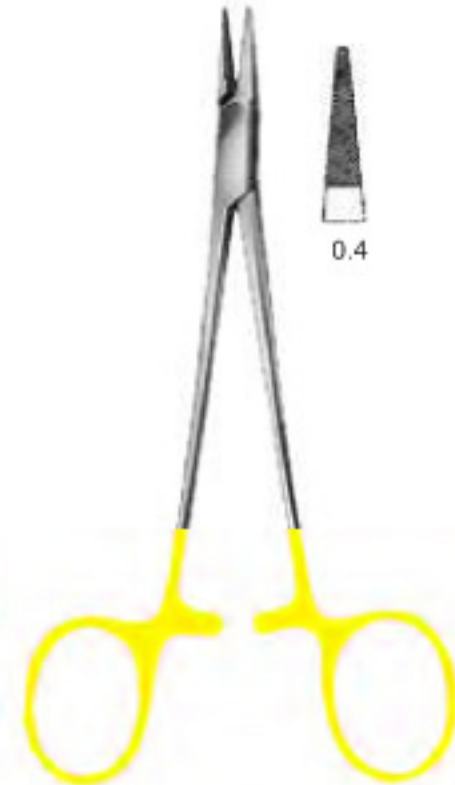

**BABY-CRILE-WOOD**

**3574**  
150mm (6")



**WEBSTER**

**3575**  
125mm (5")



**BAUMGARTNER**

**3576**  
145mm (5.3/4")

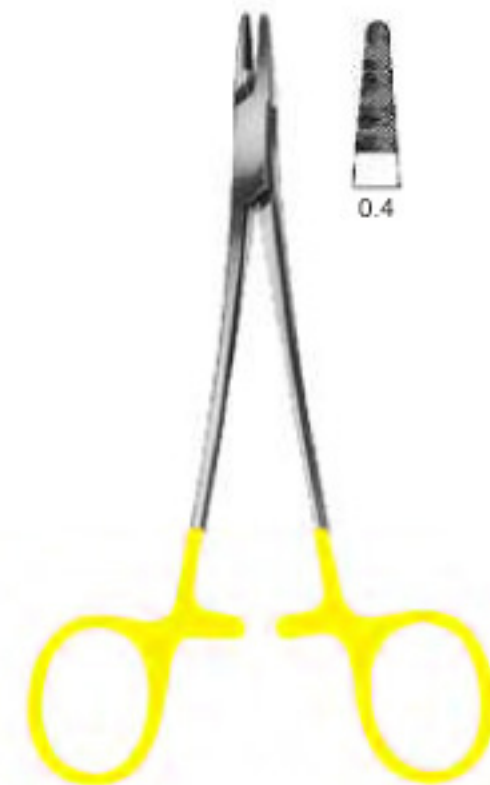

**CRILE - WOOD**

**3577**  
145mm (5.3/4")





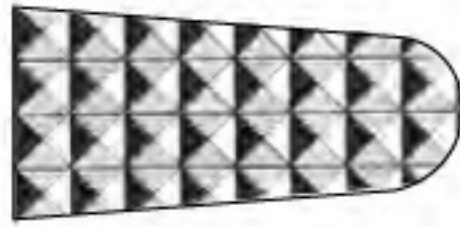

**COARSE**

For powerful needle holder patterns and wire twisters

Maximum holding capabilities for heavy needles or wire

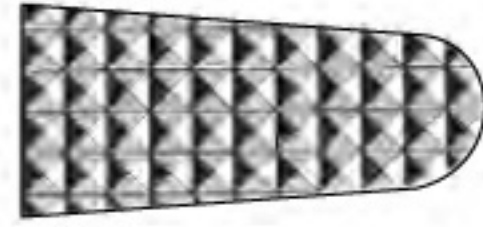

**STANDARD**

Used for example Mayo-Hegar, Mathieu Needle Holders

For needle 3-0 and larger

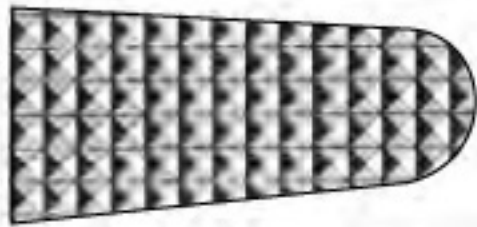

**FINE**

For delicate needle holders such as Crile Wood and Debaquey

For needle and sutures between 4-0 and 6-0

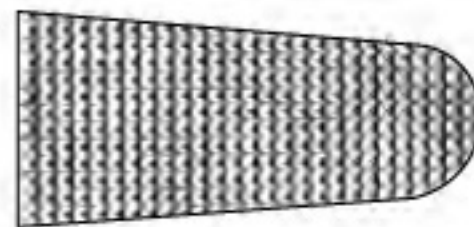

**MICRO**

For micro needle holder such as Castroviejo, Microvascular and Mini-Ryder

For delicate needle and sutures between 7-0 and 10.0



**CASTROVIEJO**

**3578**  
145mm (5.3/4")



**CASTROVIEJO**

**3579**  
145mm (5.3/4")



**CASTROVIEJO**

**3580**  
180mm (7")



**CASTROVIEJO**

**3581**  
215mm (8.1/2")



**PAYR**  
**3582**  
225mm (9")



**PAYR**  
**3583**  
280mm (11")



**GWYNNE EVANS TONSIL**  
200mm (8")  
Double ended

**3584**  
6mm wide

**3585**  
8mm wide



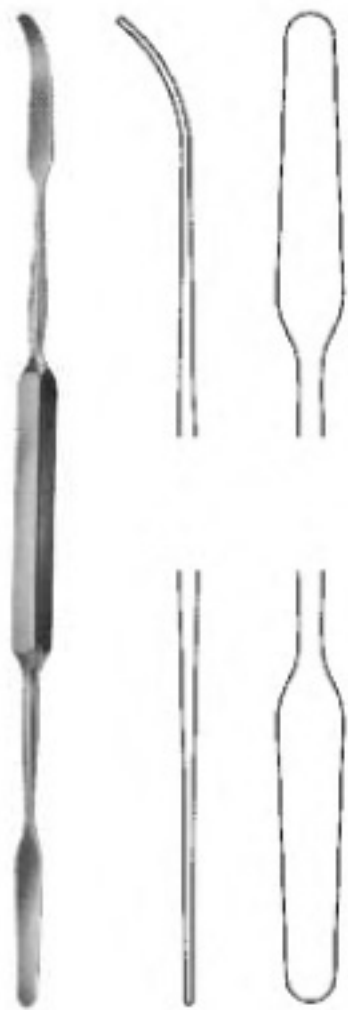

**MACDONALD**

**3586**  
185mm (7.1/4")  
Double ended



**WATSON CHEYNE**  
Fine with probe

**3587**  
125mm (5")

**3588**  
190mm (7.1/2")

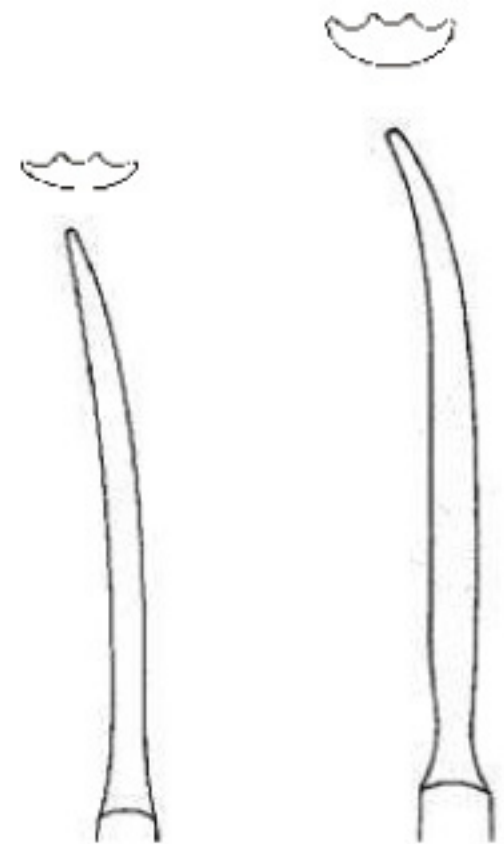

**KOCHER THYROID**

**3589**  
150mm(6")

**3590**  
170mm (6.3/4")







**LIEBRICH LACHRYMAL**

- 3591**  
No. 00 - 0 (0.7 - 0.8mm)
- 3592**  
No. 1 - 2 (0.9 - 1.1mm)
- 3593**  
No. 3 - 4 (1.3 - 1.4mm)
- 3594**  
No. 5 - 6 (1.5 - 1.6mm)



**ANEL LACHRYMAL**

- 3595**  
108mm (4.1/4") 0.6mm , small



**JOBSON HORNE**

- 3597**  
140mm (5.1/2")
- 3598**  
178mm (7")



**CAWTHORNE**

- 3596**  
140mm (5.1/2")





**BRODIE**

**3599**  
200mm (8")  
Ball point



**DIRECTORS**

**3600**  
130mm (5.1/8")

**3601**  
145mm (5.3/4")

**3602**  
160mm (6.1/4")



**3603**  
140mm (5.1/2")





**NESTED TROCARS**

**3604**  
171mm (6.3/4")  
1.9mm, 3.3mm,  
4.5mm and 6.0mm  
Set of four

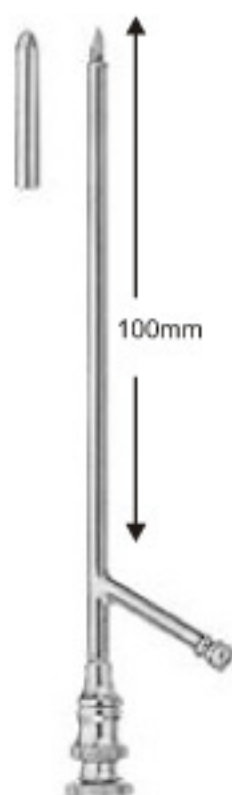

**OSCHNER GALL BLADDER**

**3605**  
I.D. 3.6mm O.D. 4.6mm

**3606**  
I.D. 5.0mm O.D. 6.0mm

**3607**  
I.D. 3.0mm O.D. 4.0mm

**3608**  
I.D. 4.3mm O.D. 5.3mm



**SUPRAPUBIC**

**3609**  
I.D. 9.0mm O.D. 10.0mm

**3610**  
I.D. 7.0mm O.D. 8.0mm







**CHARNLEY INITIAL INCISION  
RETRACTOR**  
with weight and chain

3611

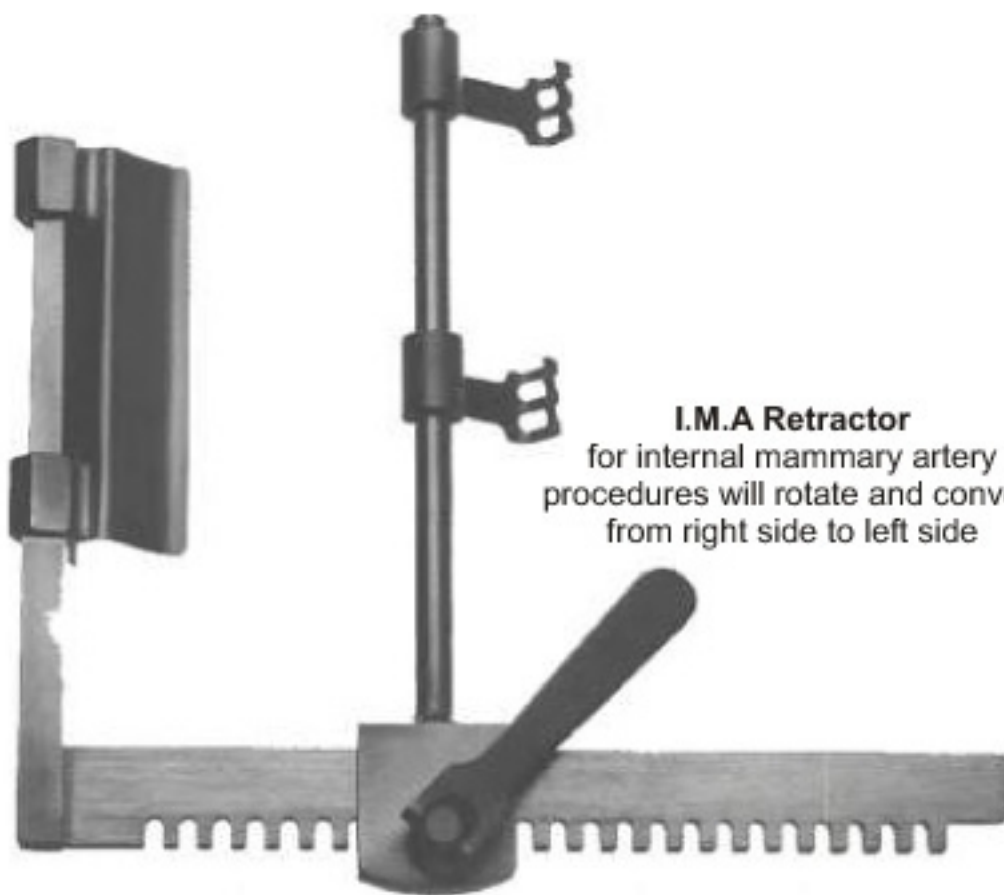

**I.M.A Retractor**  
for internal mammary artery  
procedures will rotate and convert  
from right side to left side

**I.M.A RETRACTOR**

3612

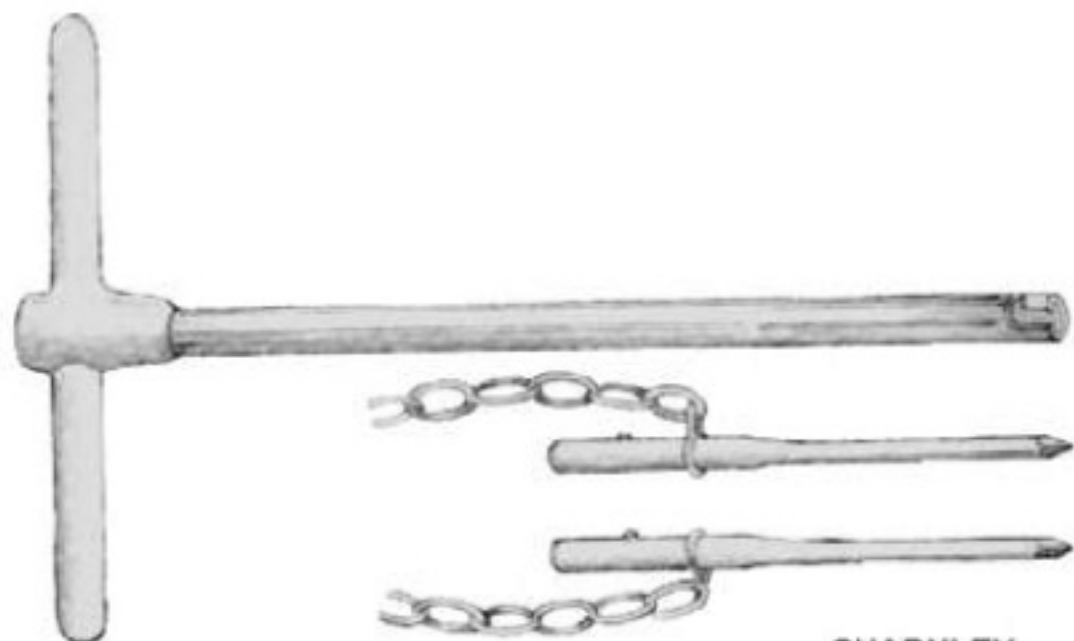

**CHARNLEY  
PIN RETRACTOR**

3613

# SELF RETAINING RETRACTORS

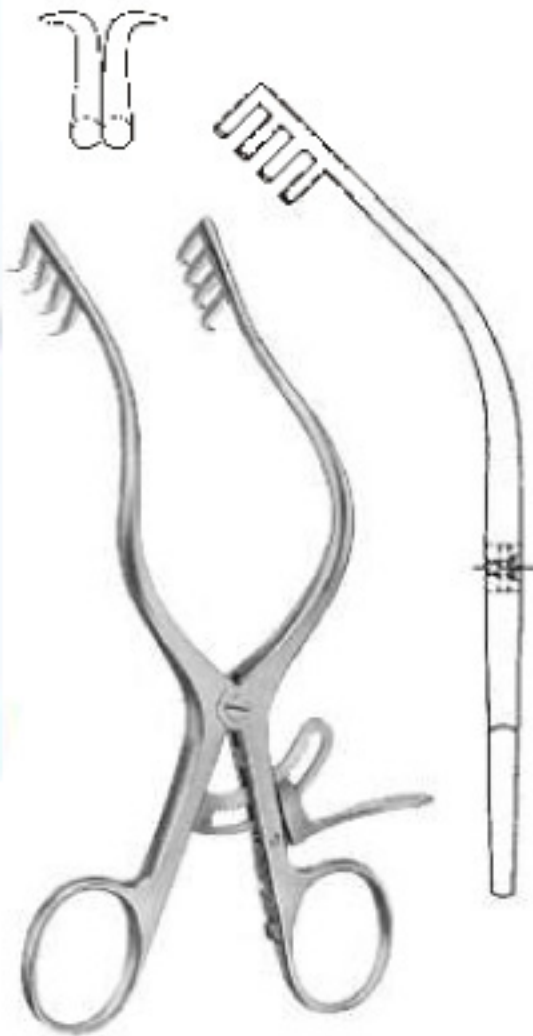

**MOLLISON**  
**3614**  
165mm (6.1/2")



**MOLLISON**  
**3615**  
133mm (5.1/4")



**PLESTER-JANSEN**  
**3616**  
140mm (5.1/2")



**PLESTER-JANSEN**  
**Right**  
**3617**  
140mm (5.1/2")

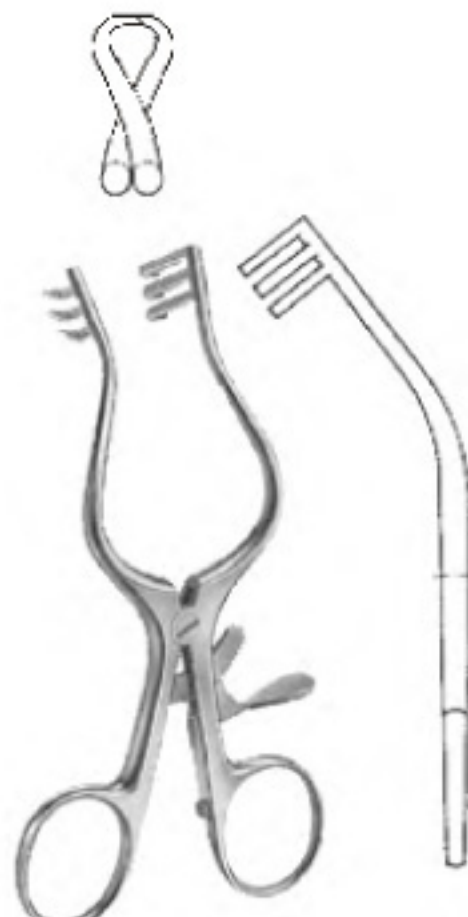

**PLESTER-JANSEN**  
**3618**  
140mm (5.1/2")

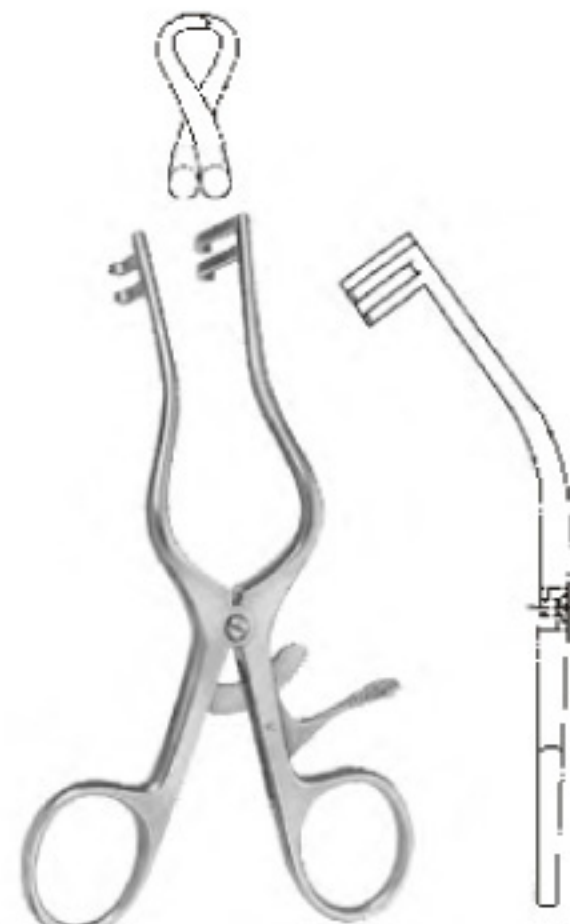

**WALACE MODIFIED**  
**PLESTER-JANSEN**  
**3619**  
140mm (5.1/2")



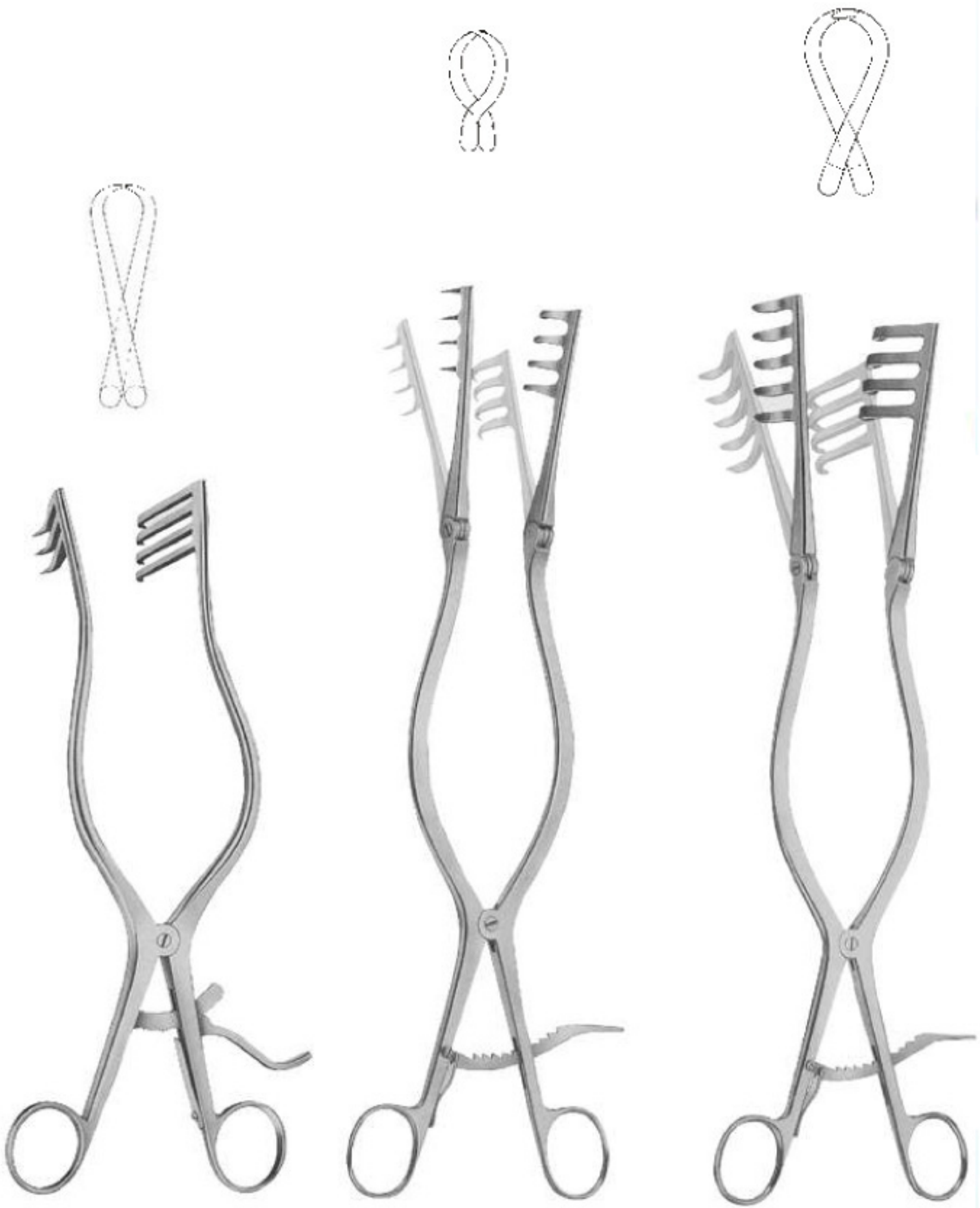

**ADSON**  
**3620**  
265mm (10.1/2")

**BECKMANN-ADSON**  
**3621**  
310mm (12")

**ADSON**  
**3622**  
320mm (12.3/4")  
Semi - sharp





**CONE**  
3623  
145mm (5.3/4")



**JANSON (SHEA)**  
3624  
105mm (4.1/8")

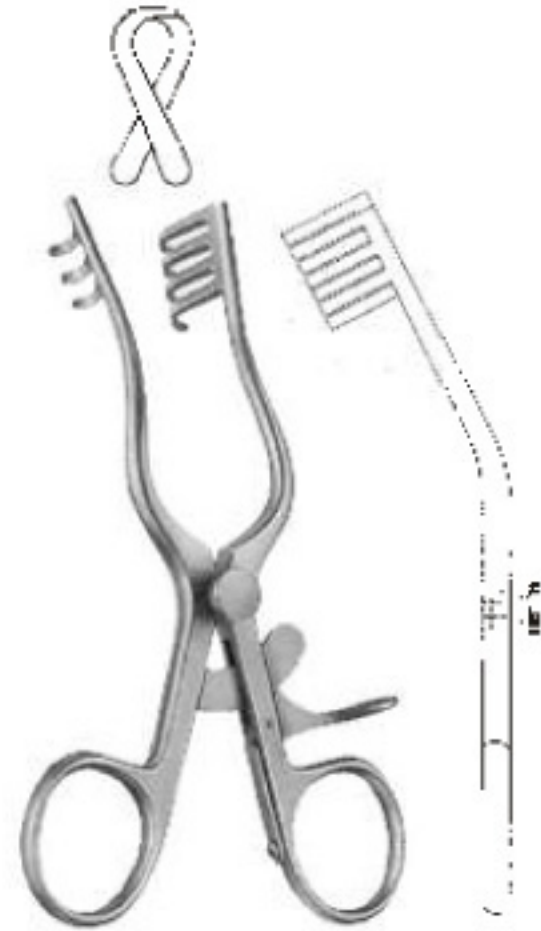

**JEFFERSON**  
3625  
140mm (5.1/2")



**HENDERSON**  
3626  
130mm (5.1/8")



**TRAVERS**  
3627  
195mm (7.3/4")  
Sharp





**TURNER WARWICK**

**3628**  
140mm x 180mm (7" x 5.1/2")  
Oval sprocket frame and four blades



**GELPI VULVA**

**3629**  
165mm (6.1/2")



**GELPI VULVA**

**3630**  
135mm (5.1/4")



**JACKSON - BURROWS**

**3631**  
165mm (6.1/2")



**FINSON**

**3632**  
70mm (2.3/4")

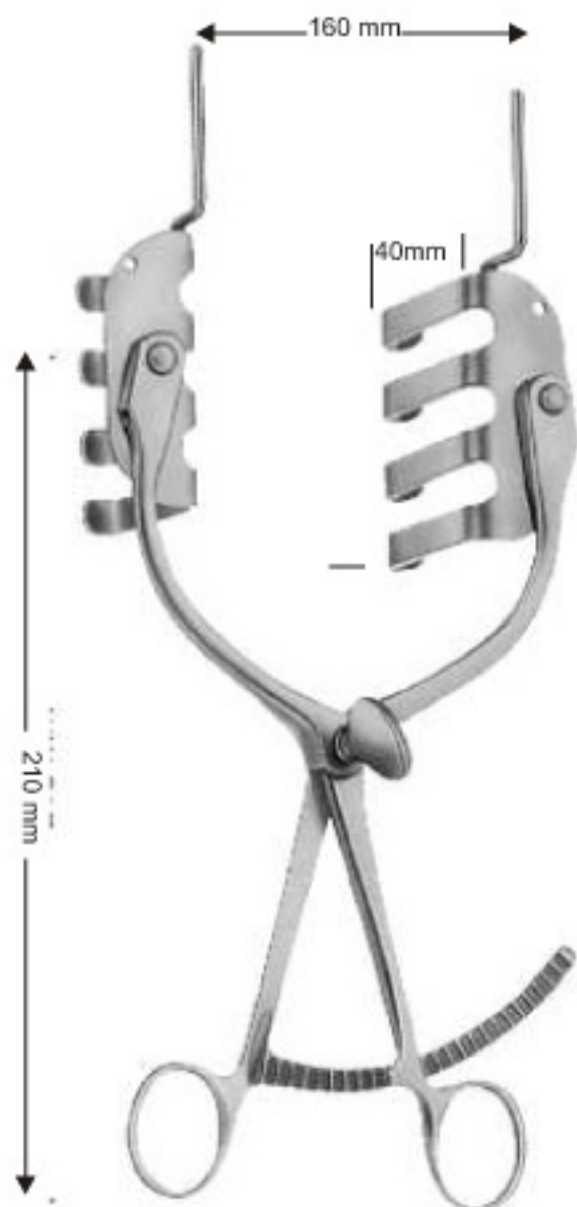

**ST MARKS HOSPITAL  
PERINEAL**  
210mm (8.3/8")

**3633**  
Blades: 70mm x 40mm



**JOLL THYROID**

**3634**  
152mm (6")



**MILLIN RETROPUBIC**

**3635**  
Blades  
55mm x 25mm  
80mm x 25mm

Centre blade:  
115mm x 45mm







**WEISLANDER**

**3636**  
110mm (4.3/8")  
2 x 3teeth, sharp



**WEISLANDER**

**3637**  
110mm (4.3/8")  
2 x 3 teeth, blunt



**RNTNE HOSPITAL**

**3638**  
159mm (6.1/4")  
3 x 4 teeth



**NORFOLK AND NORWICH**

**3639**  
215mm (8.1/2")  
4 x 5 teeth, blunt



**GOLIGHER**

**3640**

Complete with two centre blades: 51mm deep, and four lateral blades:  
2 x 51mm deep  
2 x 102mm deep



**BERKELEY ABDOMINAL**

**3641**

Blades: 35mm x 60mm



**TRAVERS**

**3642**

200mm (8")  
4 x 5 teeth  
Blunt



**IRWIN**

**3643**

178mm (7")  
4 x 5 teeth  
Sharp





**KIRSCHNER RETRACTOR SET**

**3644**  
Set comprising of:  
1 x L40-08008  
2 x L40-08009  
2 x L40-08010

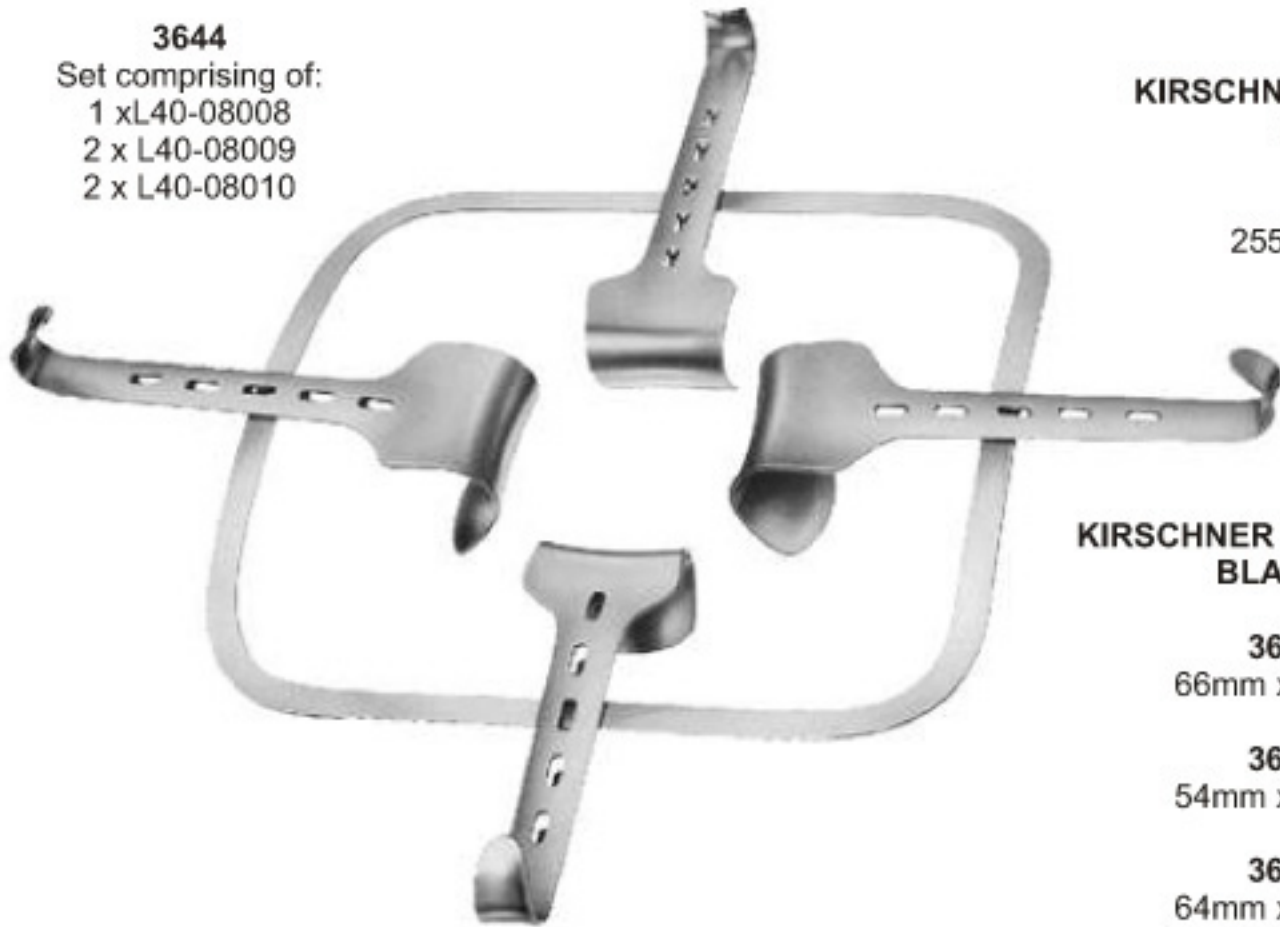

**KIRSCHNER RETRACTOR FRAME**

**3645**  
255mm square

**KIRSCHNER RETRACTOR BLADES**

**3646**  
66mm x 48mm

**3647**  
54mm x 42mm

**3648**  
64mm x 80mm

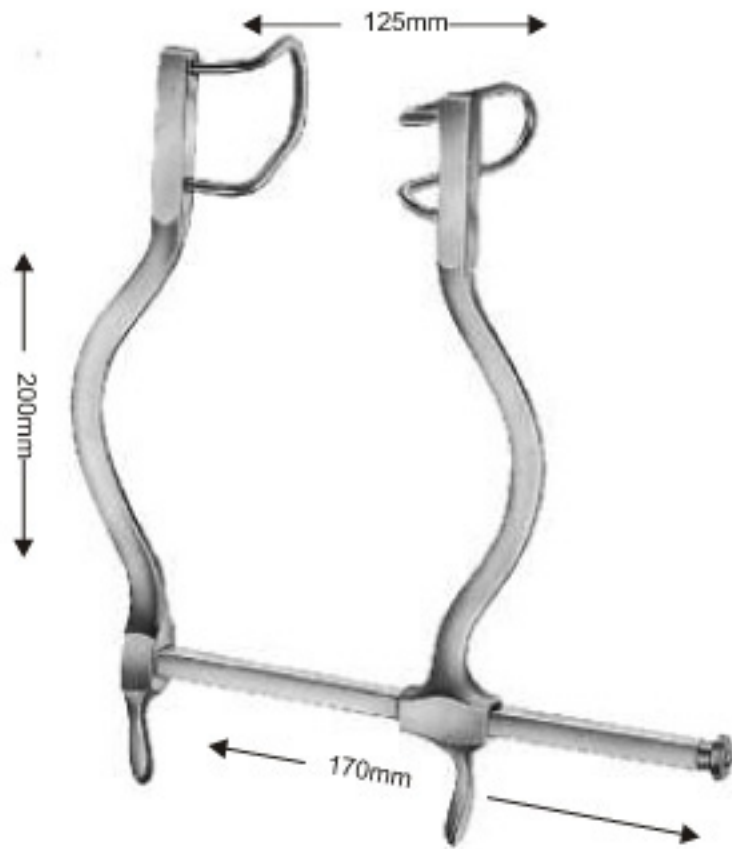

**GOSSET**

**3649**  
Blades: 55mm

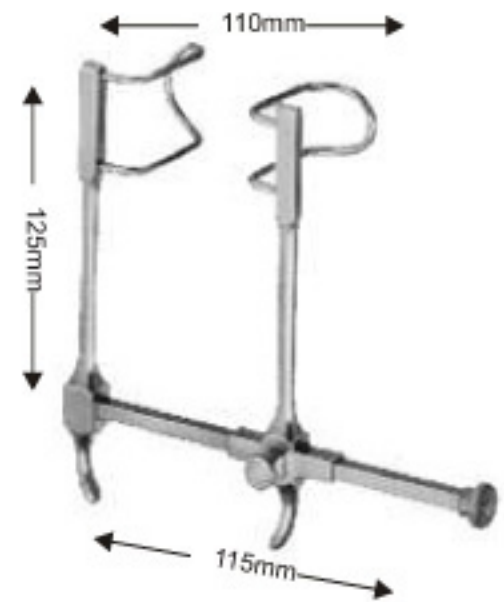

**GOSSET**

**3650**  
Blades: 38mm







**TURNER WARWICK RETRACTOR BLADES**



**3651**  
Blade: 51mm x 38mm  
Curved, blackened finish

**3652**  
Blade: 76mm x 60mm  
Curved, blackened finish



**3653**  
Blade: 89mm x 60mm  
Flat, polished front surface

**3654**  
Blade: 114mm x 60mm  
Flat polished front surface



**3655**  
13mm deep  
Single hook blade



**POZZI ABDOMINAL**

**3656**  
Blades: 62mm x 38mm  
Swivel blades



**POZZI ABDOMINAL**

**3657**  
Lateral blades:  
62mm x 38mm  
  
Center blade:  
55mm x 55mm



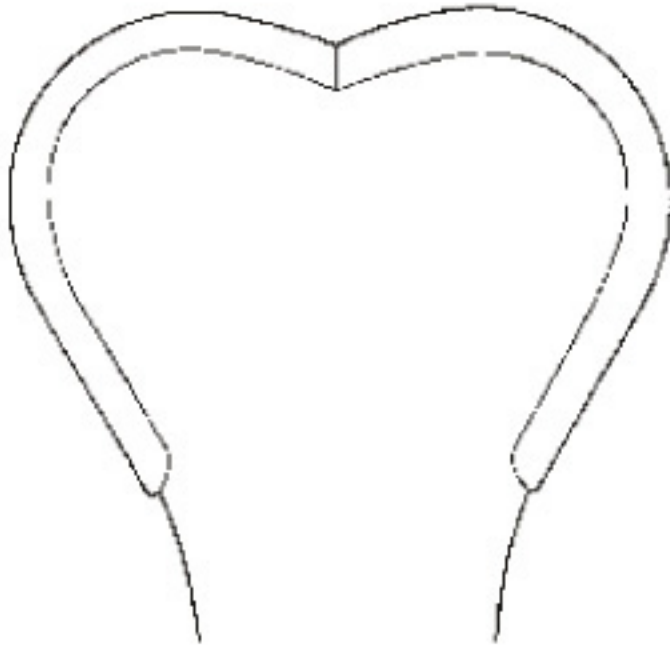

**HARRINGTON - PEMBERTON**  
Flexible

**3658**  
295mm (11.3/4")  
Blade: 175mm x 64mm



**ALLISON**

**3659**  
255mm (10")  
Blade: 40mm wide





**RETRACTOR**  
155mm (6")  
Flexible shaft



**3660**  
2 prong, sharp



**3663**  
2 prong, blunt



**3661**  
3 prong, sharp



**3664**  
3 prong, blunt



**3662**  
4 prong, sharp



**3665**  
4 prong, blunt



**RETRACTOR**



**3666**  
125mm (5")



**3667**  
135mm (5.1/4")



**3668**  
130mm (5.1/8")



**KILNER**  
150mm (6")

**3669**  
Sharp

**3670**  
Blunt







**LANGENBECK  
BONE HOOK**

**3671**  
205mm (8")  
Sharp



**LANGENBECK  
BONE HOOK**

**3672**  
205mm (8")  
Blunt



**KOCHER  
BONE HOOK**

**3673**  
220mm (8.3/4")  
Sharp



**KOCHER  
BONE HOOK**

**3674**  
220mm (8.3/4")  
Blunt



**WERTHEIM**  
**3675**  
300mm (12")  
Blade: 100mm x 40mm



**3676**  
Blade: 32mm x 19mm



**3677**  
Blade: 41mm x 19mm



**3678**  
Blade: 57mm x 19mm



**SMILLIE RETRACTORS**  
**3679**  
145mm (5.3/4")

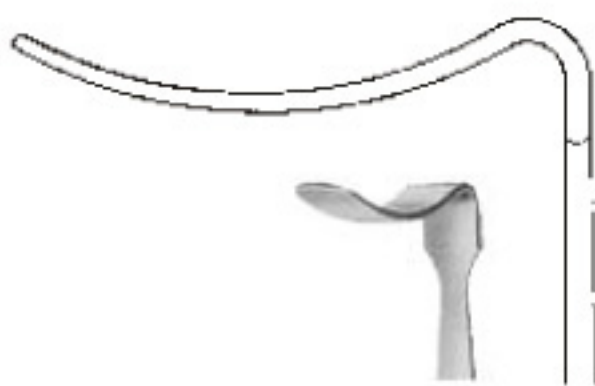

**3680**  
Blade: 10mm



**3681**





**ABDOMINAL RETRACTOR**  
240mm (9.1/2")

**3682**  
Blade: 34mm x 50mm

**3683**  
Blade: 46mm x 75mm

**3684**  
Blade: 64mm x 85mm

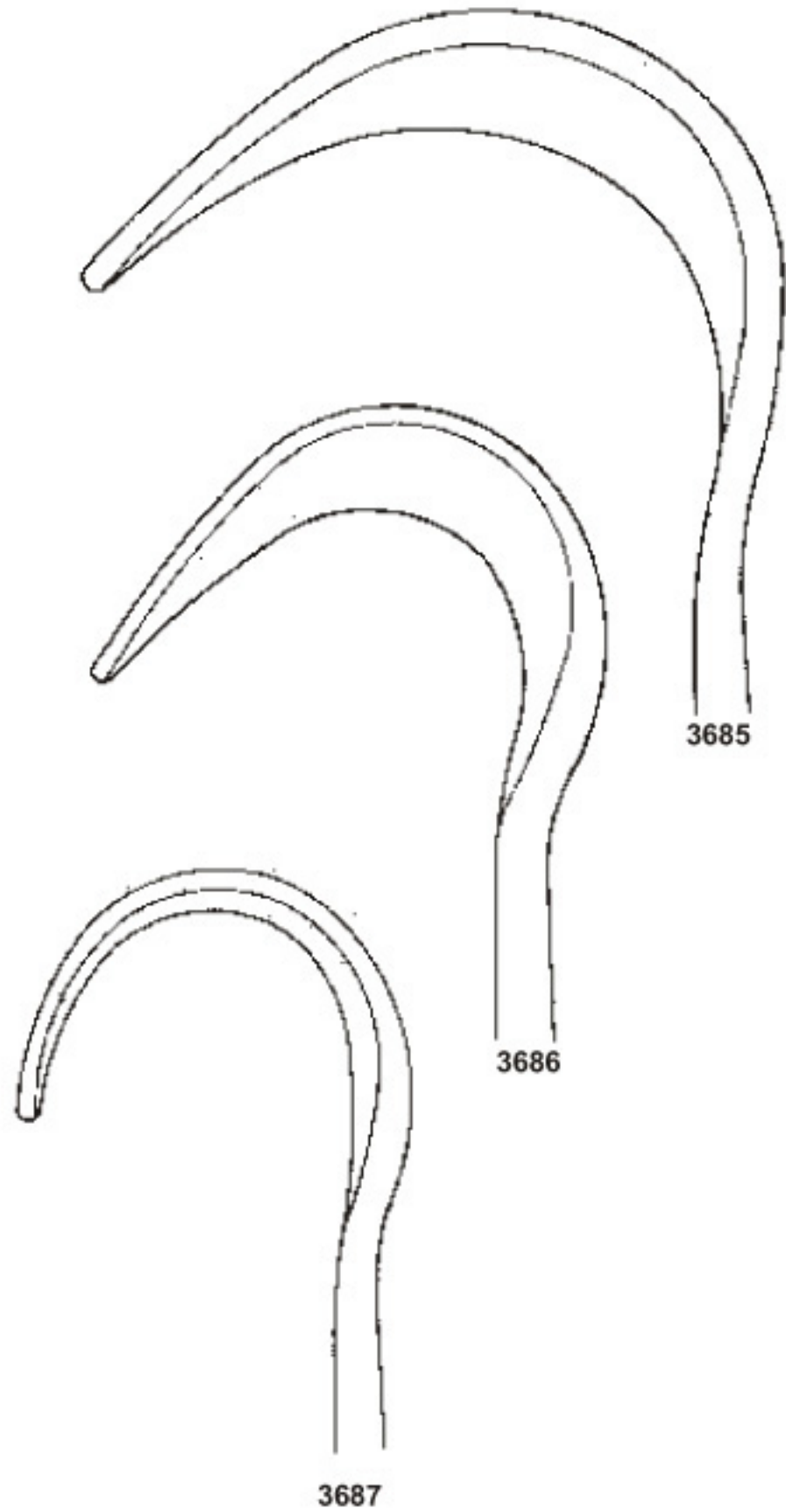





**ISRAEL**  
255mm (10")1

**3688**  
Blade: 39mm x 40mm  
Blunt



**3689**  
Blade: 47mm x 51mm  
Blunt



**3690**  
Blade: 53mm x 62mm  
Blunt

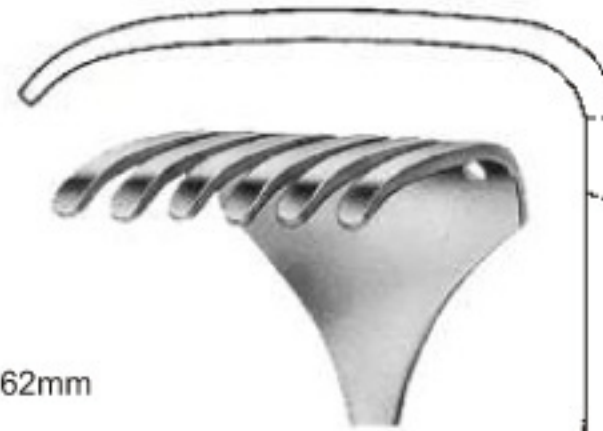

**3691**  
Blade: 70mm x 70mm  
Blunt

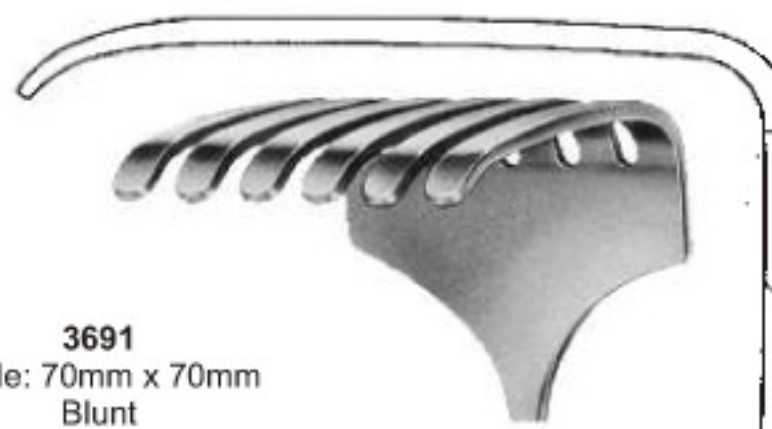



3697



3698



**LEMPERT**  
225mm (9")

**3692**  
Blade 9mm x 19mm  
Sharp

**3693**  
Blade 8.5mm x 19mm  
Blunt



**BALLANCE**  
225mm (9")

**3694**  
Blade 9mm x 29mm  
Sharp

**3695**  
Blade 8.5mm x 29mm  
Blunt



**CZERNY**

**3696**  
175mm (7")

# HAND HELD RETRACTORS



3699



3701



3703



3705



3700



3702



3704



3706

165mm (6.1/2")  
Small curve sharp

165mm (6.1/2")  
Small curve blunt



3707



3709



3711



3713



3708



3710



3712



3714

165mm (6.1/2")  
Large curve sharp

165mm (6.1/2")  
Large curve blunt





**RICHARDSON**  
240mm (9.1/2")

**3715**  
Blade: 23mm x 20mm



**3716**  
Blade: 30mm x 29mm

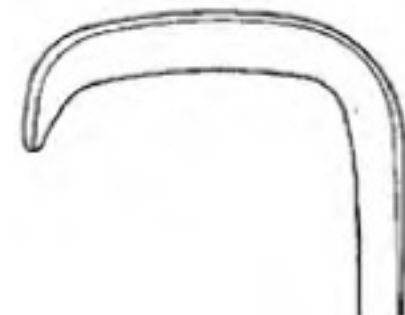

**3717**  
Blade: 37mm x 37mm

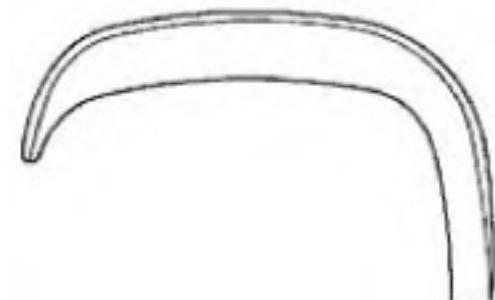

**3718**  
Blade: 47mm x 21mm







**3719**  
220mm (8.3/4")  
Blade: 15mm x 15mm

**3720**  
215mm (8.1/2")  
Blade: 20mm x 22mm

**3721**  
235mm (9.1/4")  
Blade: 28mm x 28mm

**DURHAM**  
215mm (8.1/2")

**3722**  
Blade: 10mm

**3723**  
Blade: 16mm

**MIDDELDORPF**





**KOCHER**  
**3724**  
250mm (10")  
Blade: 67mm x 25mm



**CUSHINGS VEIN RETRACTORS**  
250mm (10")



**3725**  
Blade: 14mm x 11mm



**3726**  
Blade: 18mm x 13mm



**3727**  
Blade: 22mm x 15mm



# HAND HELD RETRACTORS

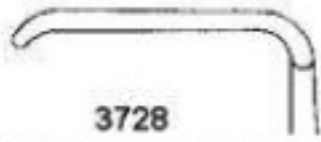

**3728**  
Blade: 25mm x 6mm

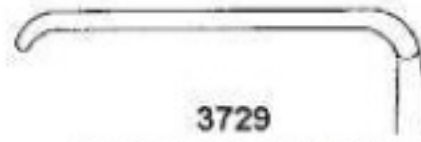

**3729**  
Blade: 35mm x 8mm

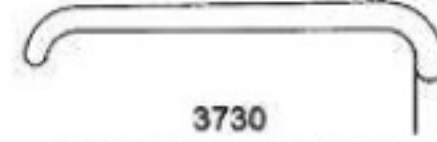

**3730**  
Blade: 35mm x 11mm

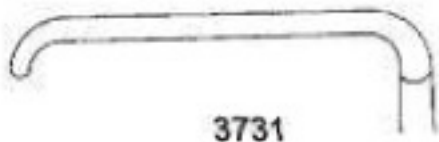

**3731**  
Blade: 35mm x 15mm



**3732**  
Blade: 41mm x 11mm

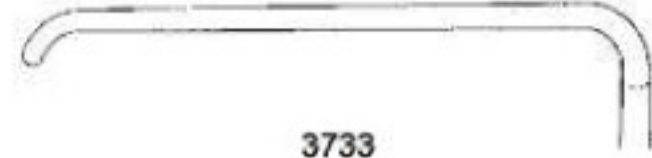

**3733**  
Blade: 55mm x 11mm



**LANGENBECK**  
215mm (8.1/2")

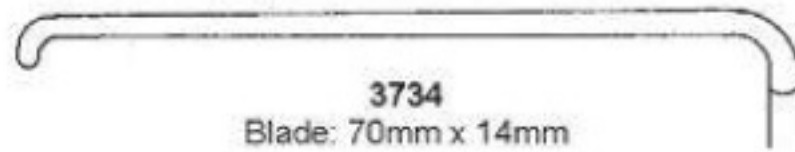

**3734**  
Blade: 70mm x 14mm



**3735**  
Blade: 80mm x 16mm





**KOCHER**  
230mm (9")

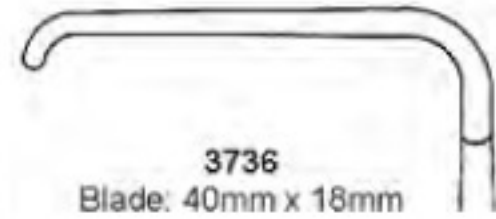

**3736**  
Blade: 40mm x 18mm

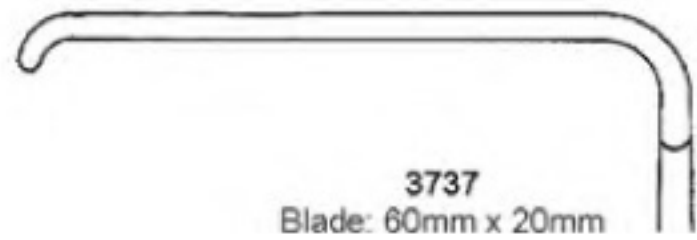

**3737**  
Blade: 60mm x 20mm

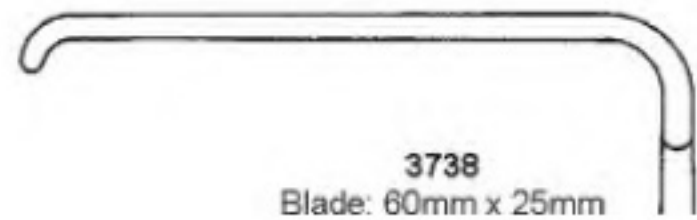

**3738**  
Blade: 60mm x 25mm



**3739**  
Blade: 75mm x 30mm

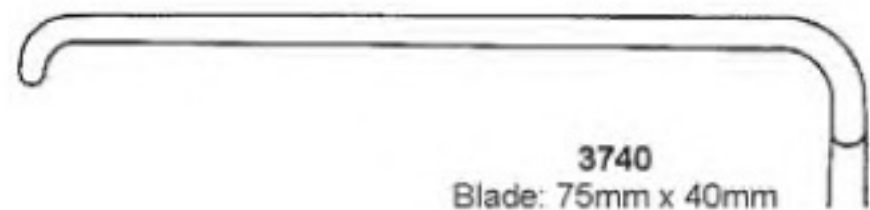

**3740**  
Blade: 75mm x 40mm





**DEAVER**

**3741**  
300mm (12")  
Blade: 38mm wide

**DEAVER**

**3742**  
310mm (12.1/4")  
Blade: 50mm wide

**DEAVER**

**3743**  
320mm (12.3/4")  
Blade: 75mm wide





**DEAVER GRIP**

**No1**  
**3744**  
310mm (12.1/4")  
Blade: 25mm wide



**DEAVER GRIP**

**No 2**  
**3745**  
310mm (12.1/4")  
Blade: 38mm wide





**DEAVER GRIP**

**No 3  
3746**  
302mm (12")  
Blade: 50mm wide



**DEAVER GRIP**

**No 4  
3747**  
310mm (12.1/4")  
Blade: 75mm wide





**DEAVER**

**3748**  
300mm (12")  
Blade: 25mm wide



**DEAVER**

**3749**  
315mm (12.1/2")  
Blade: 25mm wide







**LANE TWIN ANASTOMOSIS**

**3750**  
300mm (12") Curved



**LANE TWIN ANASTOMOSIS**

**3751**  
300mm (12") Straight





**LLOYD DAVIS RECTAL OCCLUSION**

**3752**  
315mm (12.1/2")  
Angleg



**RESANO**

**3753**  
265mm (10.1/2")  
Colon resection clamp



**DOYEN**  
165mm (6.1/2")  
Spring blades



**3754**  
Straight



**3755**  
Curved



**3758**  
Straight



**3759**  
Curved

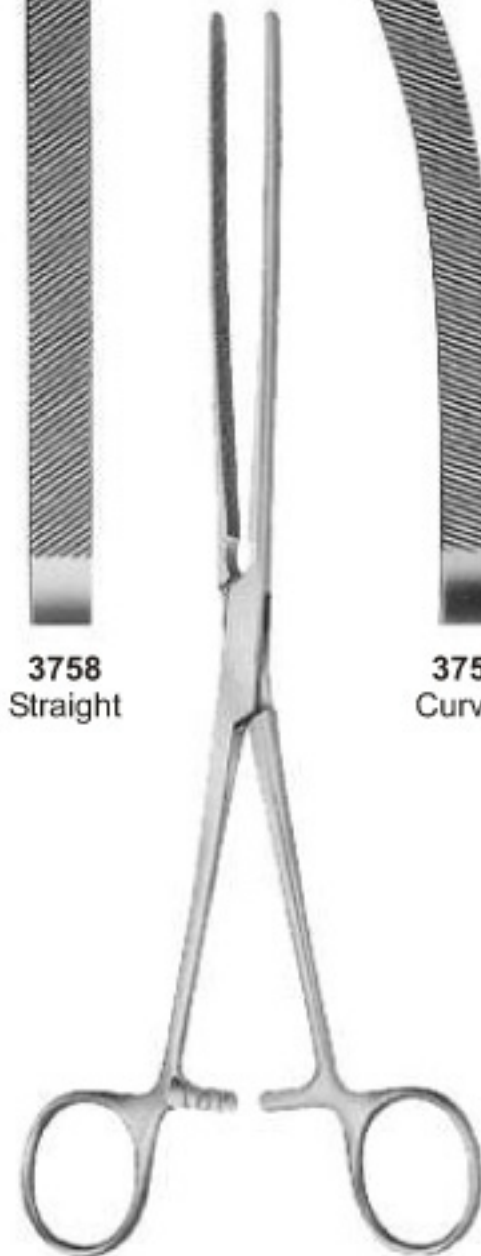

**DOYEN**  
235mm (9.3/4")  
Spring blades



**DOYEN**  
170mm (6.3/4")  
Spring blades



**3756**  
Straight



**3757**  
Curved







**DOYEN**  
230mm (9")  
Spring blades

**3760**  
Straight

**3761**  
Curved



**DOYEN (KOCHER)**  
Straight, light spring blade

**3762**  
230mm (9")

**3763**  
250mm (10")

**3764**  
280mm (11")

**3765**  
210mm (8.1/4")



**DOYEN (MAYO ROBSON)**  
Curved, light spring blade

**3766**  
230mm (9")

**3767**  
250mm (10")

**3768**  
280mm (11")

**3769**  
210mm (8.1/4")







**BLAKE**  
**3770**  
205mm (8")  
Straight



**BLAKE**  
**3771**  
205mm (8")  
Curved



**DUCT DISSECTING / DILATING  
FORCEPS**  
**3772**  
260mm (10.1/4")





**MOYNIHAN**  
**3773**  
345mm (13.3/4")  
Gall stone probe and scoop  
malleable



**OCHSNER**  
**3774**  
400mm (16")  
Gall duct probe flexible



**DESJARDINS**  
285mm (11.1/4")  
Gall duct probes, flexible





**MIXSTER**  
**3778**  
220mm (8.3/4")  
**3779**  
250mm (10")



**MOYNIHAN**  
**3780**  
230mm (9")



**MOUAT GALL BLADDER LIFTING FORCEPS**  
**3781**  
215mm (8.1/2")



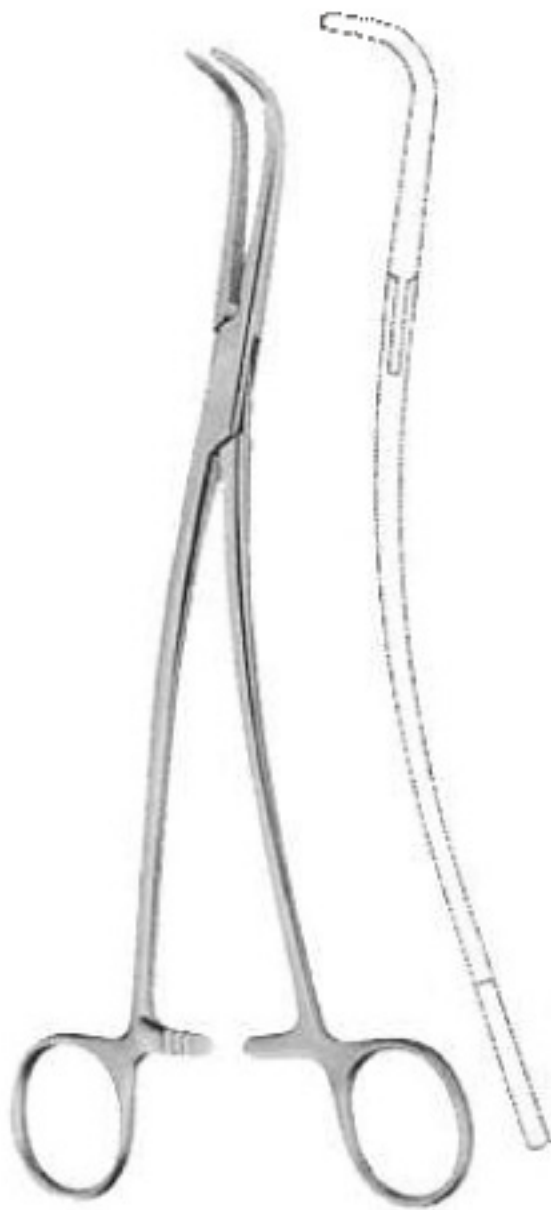

**GEARY GRANT**

**3782**  
230mm (9")  
Large curved



**LAHEY**

**3783**  
195mm (7.3/4")

**3784**  
230mm (9")



**LOWER**

**3785**  
180mm (7")





**MODIFIED DOYEN**  
**3786**  
250mm (10")  
Blade: 80mm x 30mm  
Lateral Speculum



**SIMON**  
275mm (10.3/4")  
**3787**  
Blade: 115mm X 26mm  
**3788**  
Blade: 115mm x 22mm



3789





**AUVARD**  
**3790**  
230mm (9")  
Blade: 63mm x 38-28mm  
Weight: 1.53 Kg (3lb, 60z)  
Fixed weight

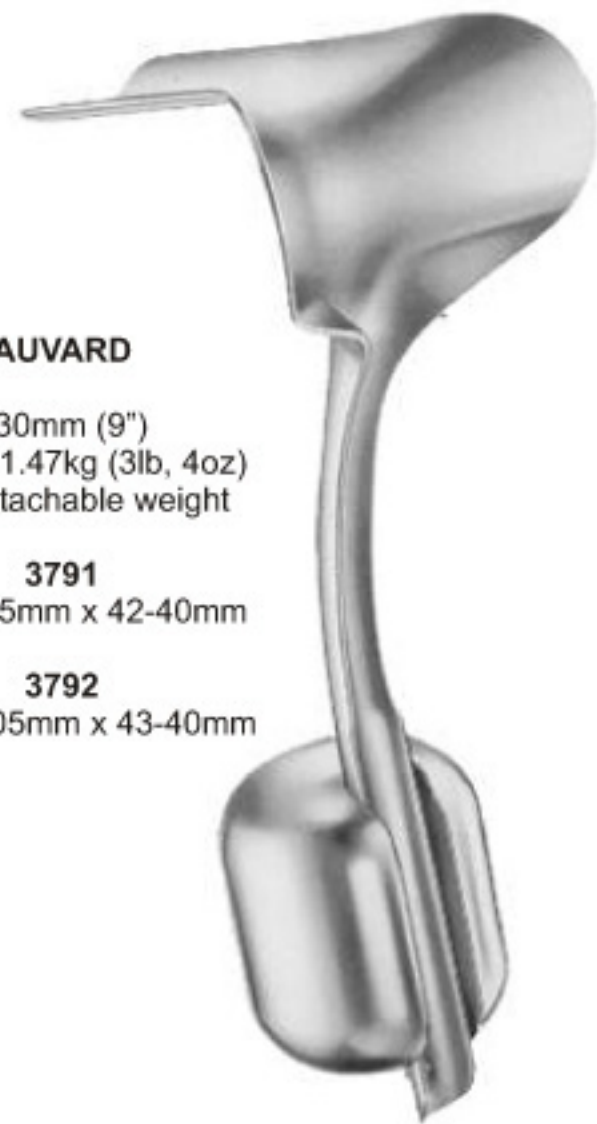

**AUVARD**  
230mm (9")  
Weight: 1.47kg (3lb, 4oz)  
with detachable weight

**3791**  
Blade: 75mm x 42-40mm

**3792**  
Blade: 105mm x 43-40mm



**3793**

<b>3794</b>	6mm
<b>3795</b>	7mm
<b>3796</b>	8mm
<b>3797</b>	9mm
<b>3798</b>	10mm
<b>3799</b>	11mm
<b>3800</b>	12mm
<b>3801</b>	13mm
<b>3802</b>	14mm
<b>3803</b>	15mm
<b>3804</b>	16mm
<b>3805</b>	17mm

**HAWKIN AMBLER**  
170mm (6.3/4")  
Cervix dilator



**3806**  
Set of sixteen  
consisting of one of  
each of: 3791 to 3806

<b>3807</b>	2mm	<b>3818</b>	13mm	<b>3829</b>	8.5mm
<b>3808</b>	3mm	<b>3819</b>	14mm	<b>3830</b>	9.5mm
<b>3809</b>	4mm	<b>3820</b>	15mm	<b>3831</b>	10.5mm
<b>3810</b>	5mm	<b>3821</b>	16mm	<b>3832</b>	11.5mm
<b>3811</b>	6mm	<b>3822</b>	17mm	<b>3833</b>	12.5mm
<b>3812</b>	7mm	<b>3823</b>	2.5mm	<b>3834</b>	13.5mm
<b>3813</b>	8mm	<b>3824</b>	3.5mm	<b>3835</b>	14.5mm
<b>3814</b>	9mm	<b>3825</b>	4.5mm	<b>3836</b>	15.5mm
<b>3815</b>	10mm	<b>3826</b>	5.5mm	<b>3837</b>	16.5mm
<b>3816</b>	11mm	<b>3827</b>	6.5mm	<b>3838</b>	17.5mm
<b>3817</b>	12mm	<b>3828</b>	7.5mm		

**HEGAR**  
185mm (7.1/4")  
Cervix dilator



Lower blade



Upper blade

**3839**  
175mm (7")  
Blade:  
70mm x 15mm

**3843**  
175mm (7")  
Blade:  
70mm x 10mm

**3840**  
180mm (7")  
Blade:  
70mm x 27mm

**3844**  
180mm (7")  
Blade:  
75mm x 23mm

**3841**  
180mm (7")  
Blade:  
75mm x 30mm

**3845**  
180mm (7")  
Blade:  
80mm x 25mm

**3842**  
185mm (7.1/4")  
Blade:  
90mm x 36mm

**3846**  
185mm (7.1/4")  
Blade:  
100mm x 32mm

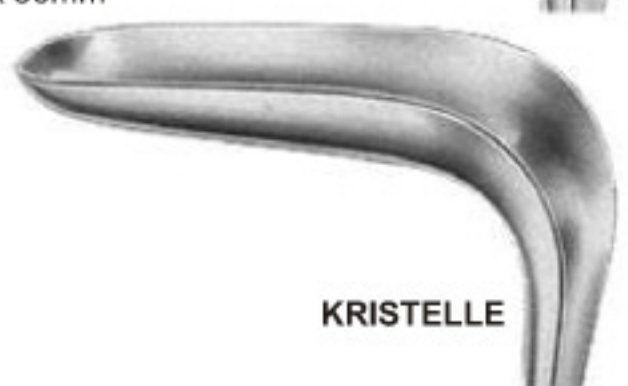

KRISTELLE



KRISTELLE







**KOGAN ENDOCERVICAL SPECULUM**

**3847**  
240mm (9.1/2")  
Graduated



**MODIFIED WERTHEIM**  
320mm (12.3/4")

**3848**  
Blade: 100mm x 25mm

**3849**  
Blade: 100mm x 30mm

**3850**  
Blade: 100mm x 35mm

**3851**  
Blade: 100mm x 40mm

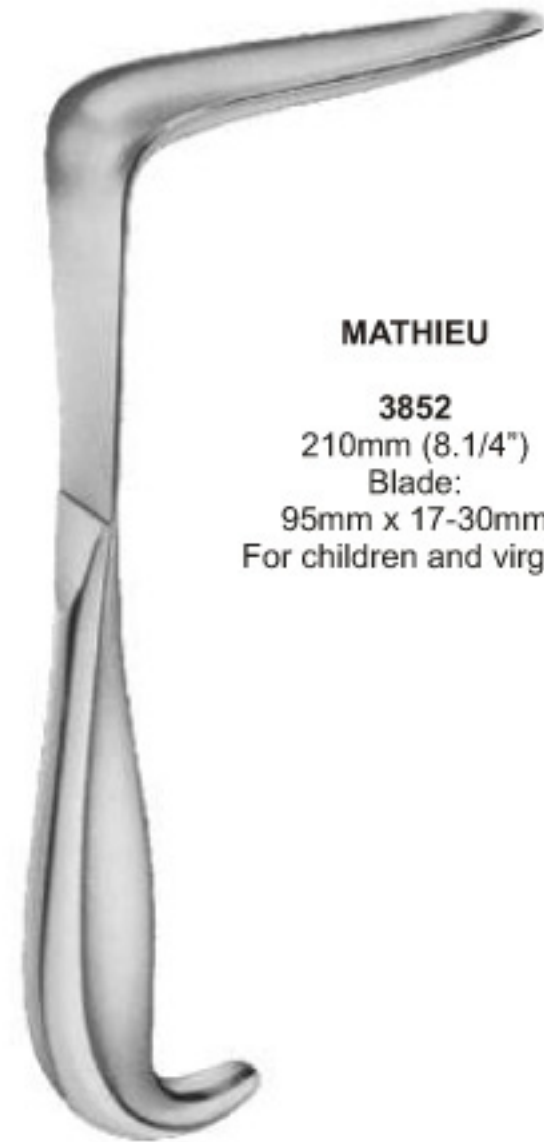

**MATHIEU**

**3852**  
210mm (8.1/4")  
Blade:  
95mm x 17-30mm  
For children and virgins

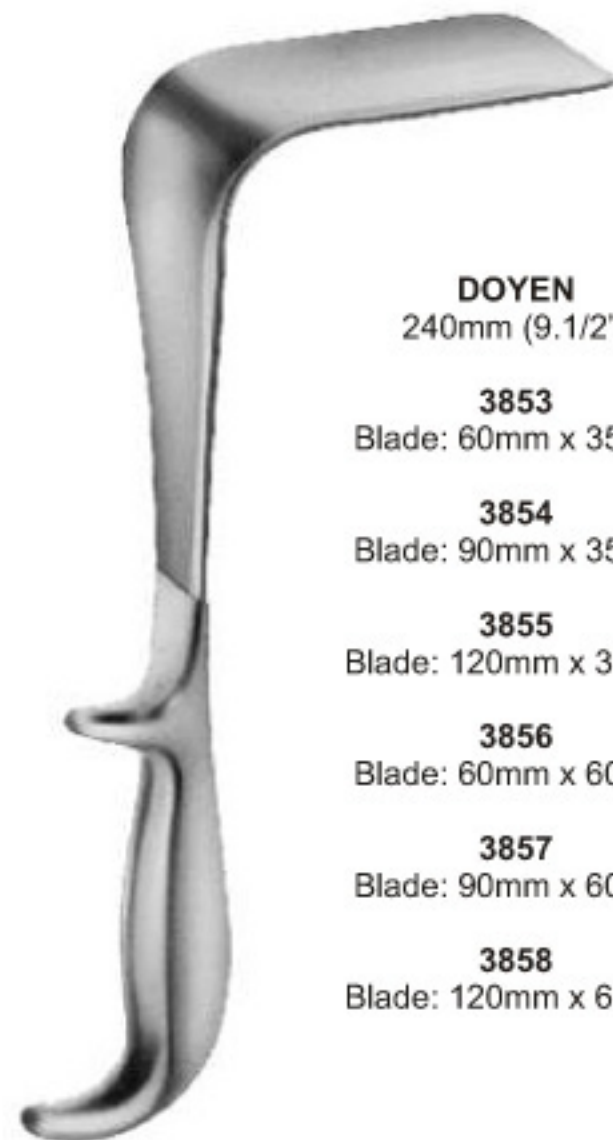

**DOYEN**  
240mm (9.1/2")

**3853**  
Blade: 60mm x 35mm

**3854**  
Blade: 90mm x 35mm

**3855**  
Blade: 120mm x 35mm

**3856**  
Blade: 60mm x 60mm

**3857**  
Blade: 90mm x 60mm

**3858**  
Blade: 120mm x 60mm







**CUSO**  
**3859**  
75mm x 17mm  
Extra small for virgins



**CUSCO**  
**3860**  
75mm x 17mm  
Extra small for virgins



**McGEE LATERAL  
VIGINAL RETRACTOR**  
with ratch handle  
**3861**



**CUSCO**  
**3862** 110mm x 37mm  
**3863** 80mm x 32mm  
**3864** 80mm x 24mm

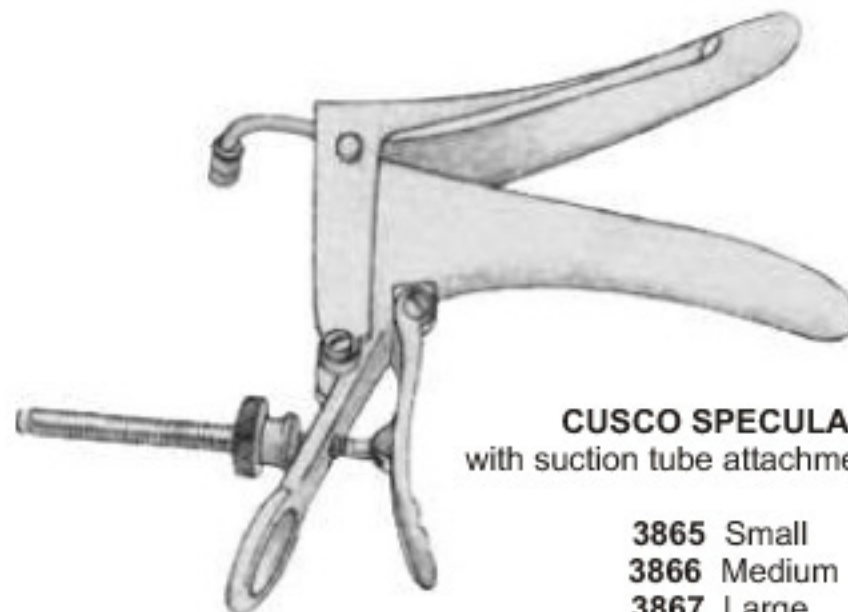

**CUSCO SPECULAM**  
with suction tube attachment black

**3865** Small  
**3866** Medium  
**3867** Large





**GRAVE**

- 3868** 75mm x 20mm
- 3869** 95mm x 30mm
- 3870** 195mm x 33mm



**PEDERSON**

- 3871** 100mm x 22 mm
- 3872** 120mm x 25mm



**SIMS**

- 3873**  
125mm (5")  
Small  
70mm x 26mm  
75mm x 30mm

- 3874**  
150mm (6")  
Medium  
75mm x 30mm  
80mm x 35mm

- 3875**  
175mm (7")  
Large  
80mm x 36mm  
90mm x 40mm





**CLUTTON URETHRAL SOUNDS**

265mm (10.1/2")

Set twelve **3876**

Set Comprising one of each of:

- 3877** 6/10 f.g (2/3.33mm)
- 3878** 8/12 f.g (2.66/4.66mm)
- 3879** 10/14 f.g (3.33/4.66mm)
- 3880** 12/16 f.g (4/5.33mm)
- 3881** 14/18 f.g (4.66/6mm)
- 3882** 16/20 f.g (5.33/6.66mm)
- 3883** 18/22 f.g (6/7.33mm)
- 3884** 20/24 f.g (6.66/8mm)
- 3885** 22/26 f.g (7.33/8.66mm)
- 3886** 24/28 f.g (8/9.33mm)
- 3887** 26/30 f.g (8.66/9.33mm)
- 3888** 28/32 f.g (9.33/10.66mm)



**3892**  
12 f.g (4mm)

**3893**  
8 f.g (2.66mm)

**3894**  
10 f.g (3.33mm)

**3895**  
14 f.g. (4.66mm)

**3896**  
16 f.g. (5.33mm)



**FEMALE CATHETERS**  
160mm (6.1/4")







**TURNER WARWICK (HEY GROVES)  
URETHRAL STAFF**

**3897**  
Black finish 180mm (7")



**TURNER WARWICK  
DISSECTING SCISSORS**

Curved, with insulation shanks  
and universal diathermy  
attachment

**3898**  
145mm (5.3/4")

**3899**  
180mm (7")

**3900**  
230mm (9")



**TURNER WARWICK  
NEEDLE HOLDER**

**3901**  
Straight, right hand model,  
black finish 215mm (8.1/2")



**TURNER WARWICK  
NEEDLE HOLDER**

**3902**  
Curved, right hand model,  
black finish 215mm (8.1/2")

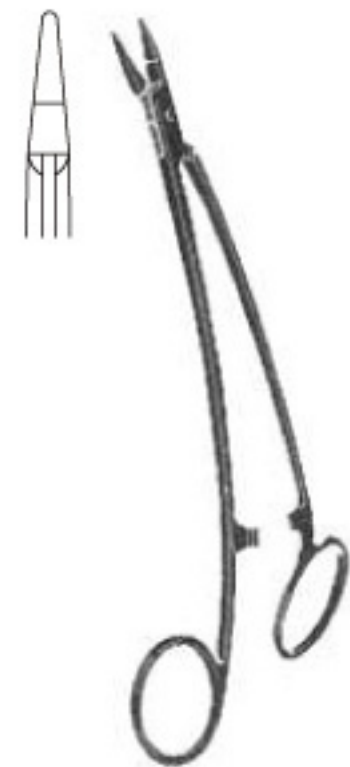

**TURNER WARWICK  
NEEDLE HOLDER**

**3903**  
Straight, left hand model,  
black finish 215mm (8.1/2")







**3905**  
Double ended  
4/9 f.g and 7/12 f.g  
1.33/3mm and 2.33/4mm



**3906**  
Double ended  
10/15 f.g and 13/18 f.g  
3.33/5mm and 4.33/6mm



**3907**  
Double ended  
16/21 f.g and 19/24 f.g  
5.33/7mm and 6.33/8mm



**3908**  
Double ended  
22/27 f.g and 25/30 f.g  
7.33/9mm and 8.33/10mm

**TURNER - WARWICK METAL  
DILATORS**

**3904**

Set of comprising of:

- 1 x 3905
- 1 x 3906
- 1 x 3907
- 1 x 3908
- 1 x 3909



**3909**  
Double ended  
28/33 f.g and 31/36 f.g





**MILLIN**

**3910**  
235mm (9.1/4")  
Lobe grasping forceps



**MILLIN**

**3911**  
245mm (9.3/4")  
Lobe grasping forceps



**MILLIN**

**3912**  
240mm (9.1/2")  
Bladder neck spreader



**CUNNINGHAM  
PENILE CLAMPS**  
With foam rubber lining

**3913**  
Small

**3914**  
Medium

**3915**  
Large



**THOMPSON-WALKER  
PENILE CLAMP**

**3916**  
115mm (4.1/2")



**PENILE CLAMP**

**3918**  
130mm (5.1/8")

**MOULDED RUBBER SHEATHS**

**3917**





**RANDALL**  
Renal Calculus Forceps

**3919**  
A  
230mm (9")



**3920**  
B  
200mm (8")



**3921**  
C  
195mm (7.3/4")



**3922**  
D  
180mm (7")



**BLADDER SPATULA**

**3923**  
235mm (9.3/4")  
Blade: 91mm x 61mm



**MILLIN**

**3924**  
245mm (9.3/4")  
Ligature holding forceps





**GABRIEL METAL AND GLASS  
SYRINGE SET**

**Consisting of**

- 3925 Gabriel needle, straight
- 3926 Gabriel needle, angled
- 3927 Gabriel syringe, 10ml



**GABRIEL NEEDLES**

Diameter: 0.9mm

**3928**  
75mm (3")  
Straight

**3929**  
100mm (4")  
straight

**3930**  
100mm (4")  
Angled

**GABRIEL SYRINGES**

**3931**  
3ml

**3932**  
10ml



**GABRIEL METAL AND GLASS  
SYRINGE SET**

- 3928 Gabriel needle, straight
- 3929 Gabriel needle, straight
- 3930 Gabriel needle, angled
- 3931 Gabriel syringe, 3ml
- 3932 Gabriel syringe, 10ml



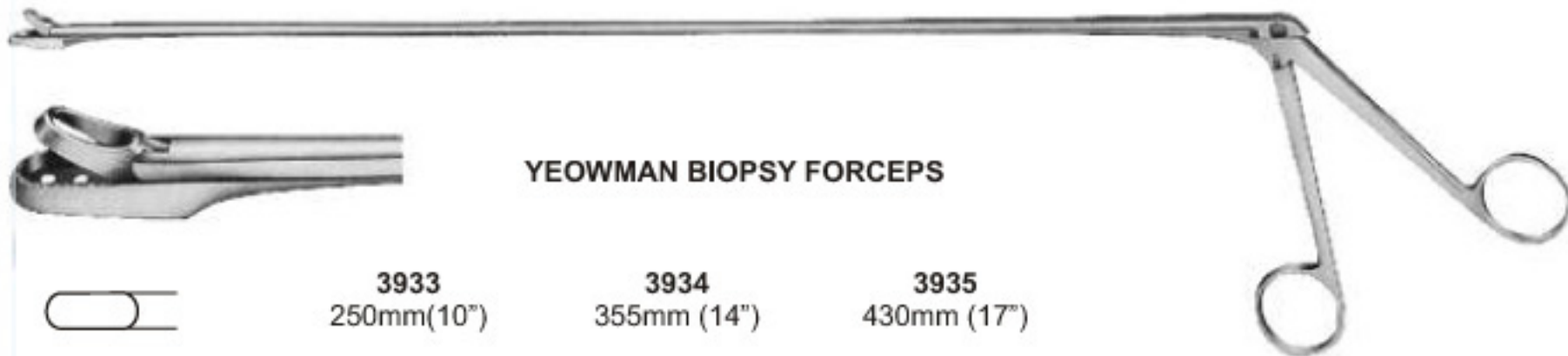

**YEOWMAN BIOPSY FORCEPS**



**3933**  
250mm(10")

**3934**  
355mm (14")

**3935**  
430mm (17")

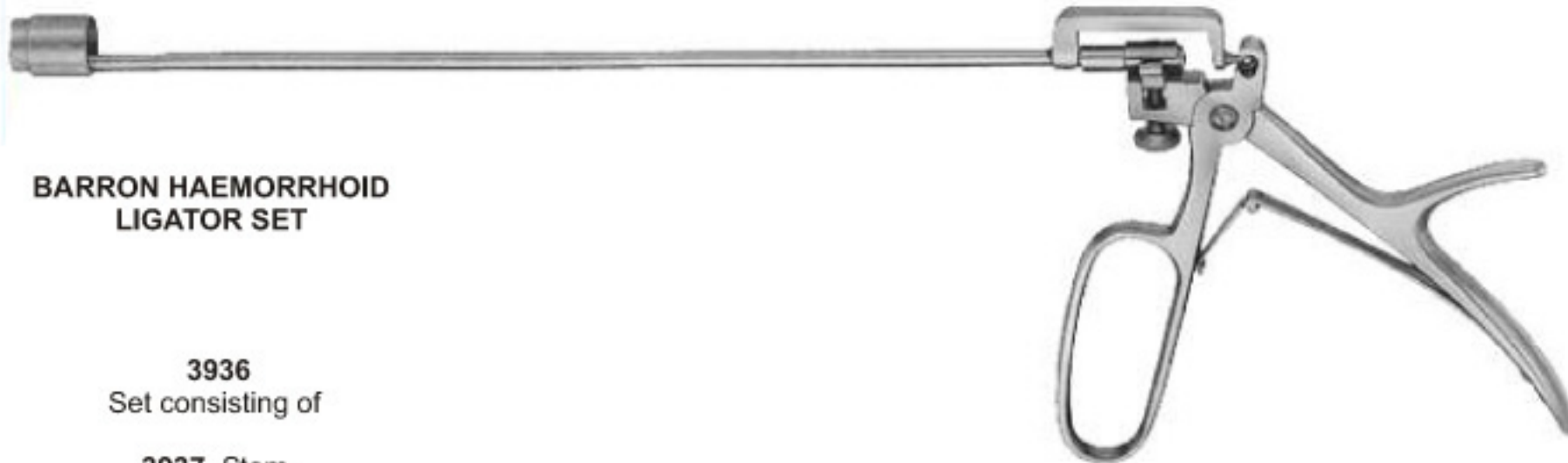

**BARRON HAEMORRHOID  
LIGATOR SET**

**3936**  
Set consisting of

**3937** Stem

**3938** "O" Ring

**3939** Conical loader for  
"O" Ring

**3940** universal Handle

**3941**  
215mm (8.1/2")  
Stem Only

**3942**  
Pack of 300  
"O" Rings

**3943**  
Conical loader only

**3944**  
Universal handle

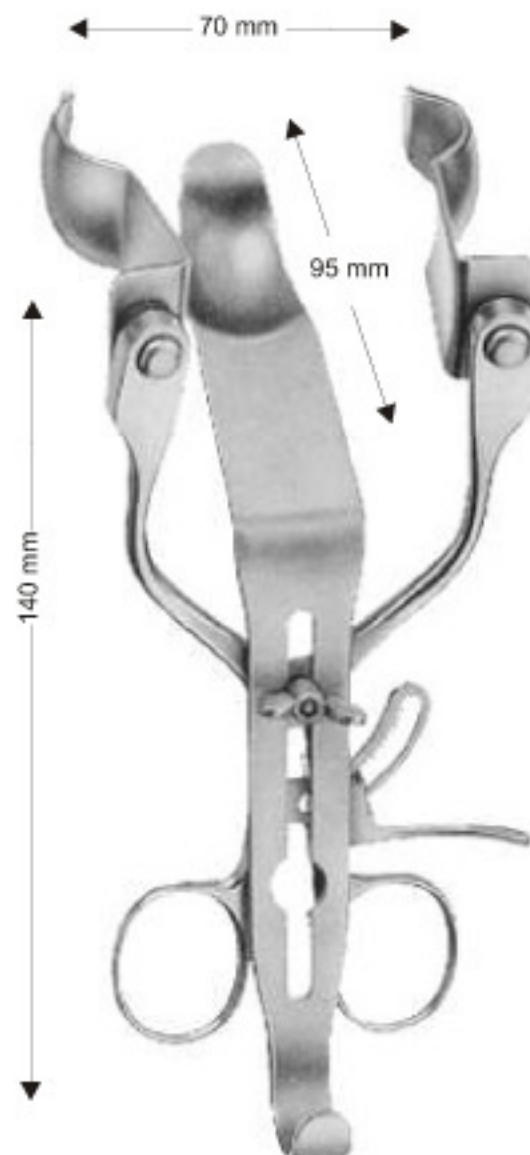

**PARK ANAL AND  
SPHINCTERECTOMY  
RETRACTOR**

**3945**  
Complete with:  
Centre Blade: 95mm  
Pair Blades: 70mm 3923  
Pair Blades: 93mm 3924

**3946**  
Spare Blades 70mm

**3947**  
Spare Blades 93mm



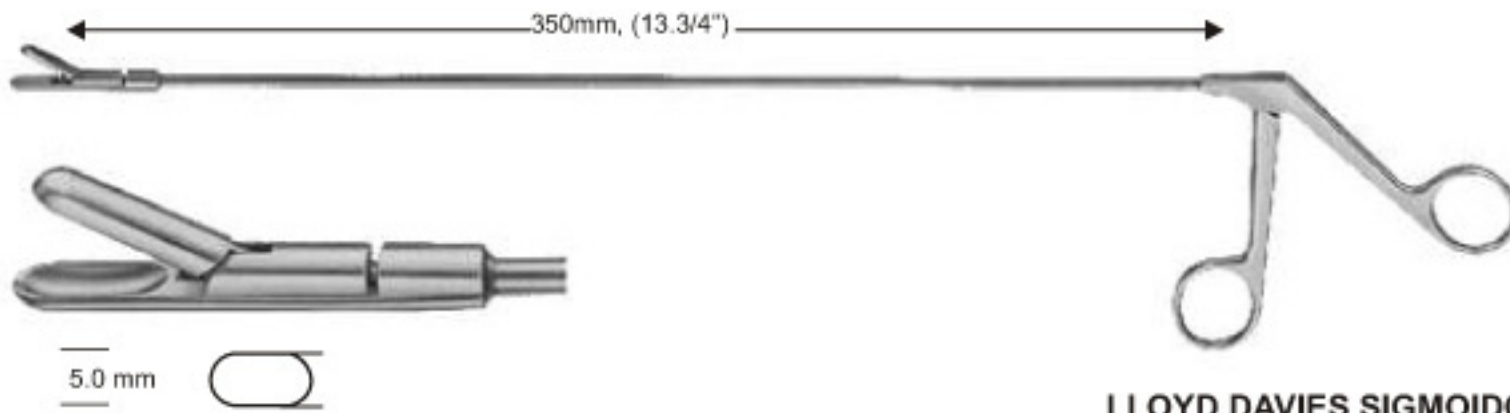

**LLOYD DAVIES SIGMOIDOSCOPE  
BIOPSY FORCEPS**

**3948**  
350mm (13.3/4")



**OFFICER  
BIOPSY FORCEPS**

**3949**  
430mm (17")  
Jaws 8mm

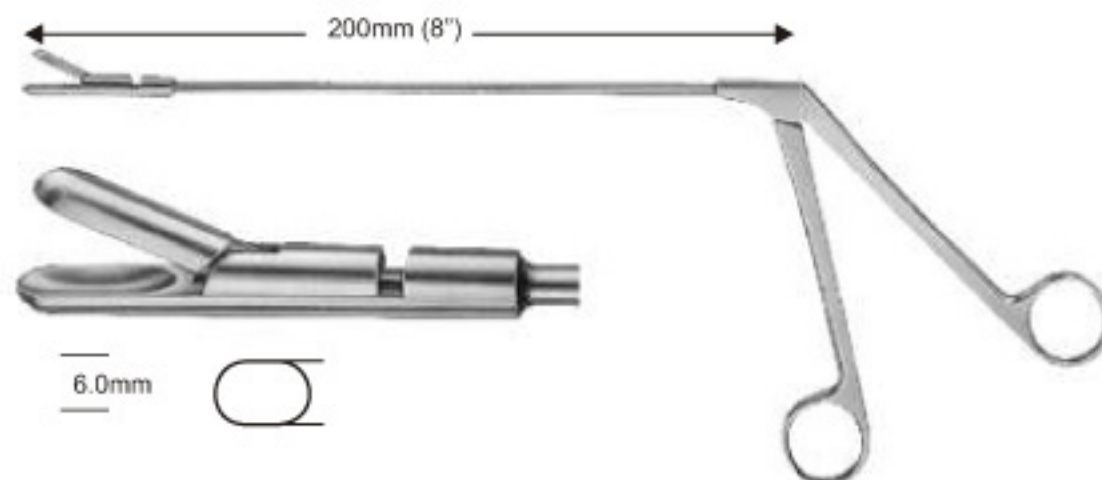

**WALTON RECTAL  
BIOPSY FORCEPS**

**3950**  
200mm (8")  
Laterally angled shanks



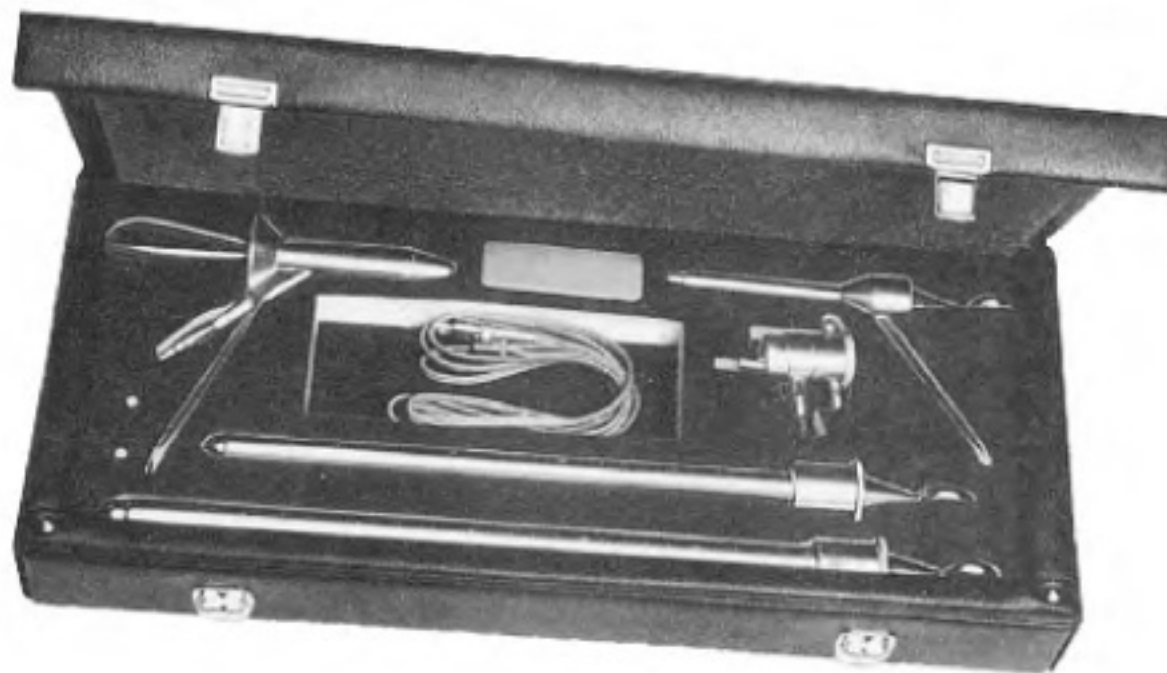

**LLOYD DAVIES (ST MARKS PATTERN)  
MAJOR SIGMOIDOSCOPE AND  
PROCTOSCOPE SET**

**3951**  
Set of consisting  
Naunton Morgan Rectal Speculum (17mm)  
Lloyd Davies Proctoscope (10mm)  
Fibre light carrier  
Lloyd Davies Sigmoidoscope (16mm)  
Lloyd Davies Sigmoidoscope (20mm)  
Case



**LLOYD DAVIES (ST MARKS PATTERN)  
COMBINATION SIGMOIDOSCOPE SET**

**3952**  
Consisting of  
Fibre light carrier  
Lloyd Davies Sigmoidoscope (16mm)  
Lloyd Davies Sigmoidoscope (20mm)  
Case







**GRAEME ANDERSON  
RECTAL SPECULUM**

**3953**  
190mm (7.1/2")  
Diameter: 19mm



**GABRIEL RECTAL SPECULUM**

**3954**  
64mm (2.1/2")  
Diameter: 25mm



**KELLY PROCTOSCOPE**

**3955**  
140mm (5.1/2") Diameter, 22mm



**SIMS RECTAL SPECULUM**

**3956**  
160mm (6.1/4")







**PRATT RECTAL SPECULUM**  
**3957**  
205mm (8")



**CZERNY RECTAL SPECULUM**  
**3958**  
225mm (9")



**MCEVEDY RECTAL SPECULUM WITH BATTERY HANDLE**  
**3959**  
150mm (6") Diameter: 27mm



**NAUNTON MORGAN RECTAL SPECULUM**  
165mm (6.1/2")  
**3960**  
Diameter: 17mm  
With fibre light carrier  
**3961**  
Diameter: 21mm  
With fibre light carrier  
**3962**  
Diameter: 24mm  
With fibre light carrier





3963



3964



3965



3966



3967



**GWILLIAM  
HYSTERECTOMY**  
200mm (8")

**3963**  
Straight

**3964**  
Curved



**HEANY  
HYSTERECTOMY FORCEPS**  
200m (8")

**3965**  
Curved, single tooth



**HEANY**  
**3966**  
205mm (8")

**3967**  
245cm (9.3/4")





**3968**



**3969**



**3970**



**3971**



**3972**



**3973**



**MIKULICZ  
3968  
180mm (7")**

**3969  
205mm (8")**



**PEROTONEUM  
3970  
205mm (8")**

**3971  
205mm (8")**



**FAURE  
3972  
205mm (8")**

**3973  
205mm (8")**





**I.U.D. REMOVING HOOK**

**3974**  
320mm (12.1/2")



**WRIGLEY**

**3975**  
250mm (10")



**KIELLAND**

**3976**  
402mm (16.3/4")





**BARNES**  
**3977**  
 410mm (16")  
 With Simpson handles and  
 Neville axis traction rod



**FRENCH MODEL  
 PELVIMETER**  
**3978**  
 330mm (13")  
 External and internal  
 Graduated to 50 and  
 22cms



**VACUME  
 EXTRACTION  
 SUCTION HEAD**  
**3979** 40mm  
**3980** 50mm  
**3981** 60mm



**AMNIOTOME**  
**3982**  
 240mm (9.1/2")





**3983**  
140mm (5.1/2")  
Pistol Grip



**3984**  
140mm (5.1/2")  
Pistol grip



**Shaft only**  
**3985** 200mm (8")  
**3986** 250mm (10")

**Biopsy cutting**



**3987** ⊕

**3988** ⊕



**3989** ⊕



**3990** △

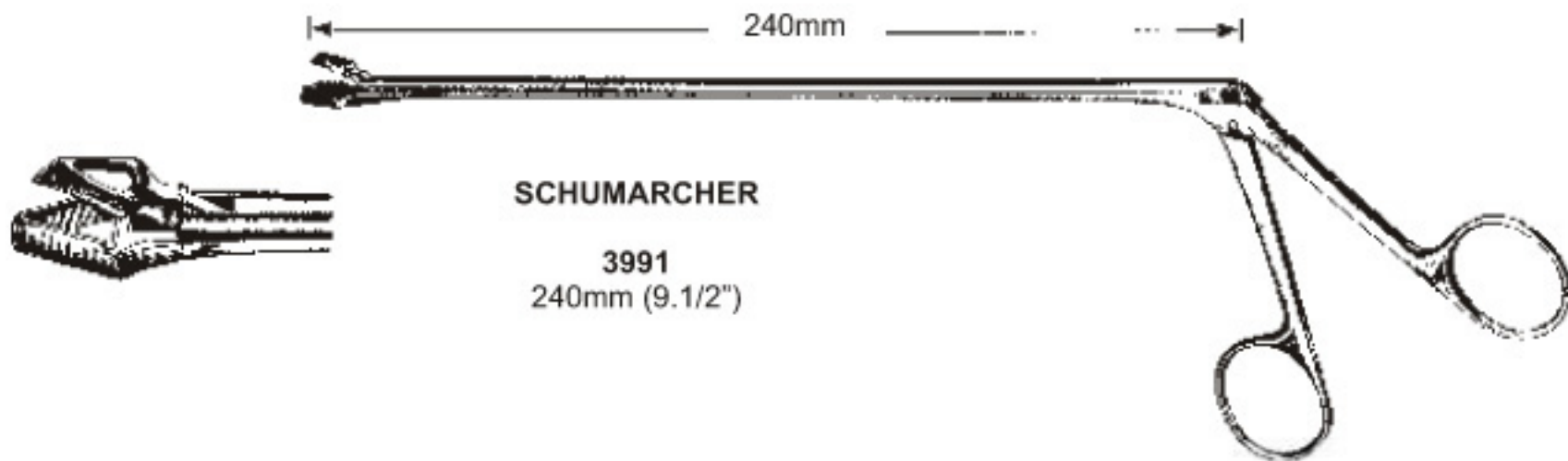

**SCHUMARCHER**  
**3991**  
240mm (9.1/2")

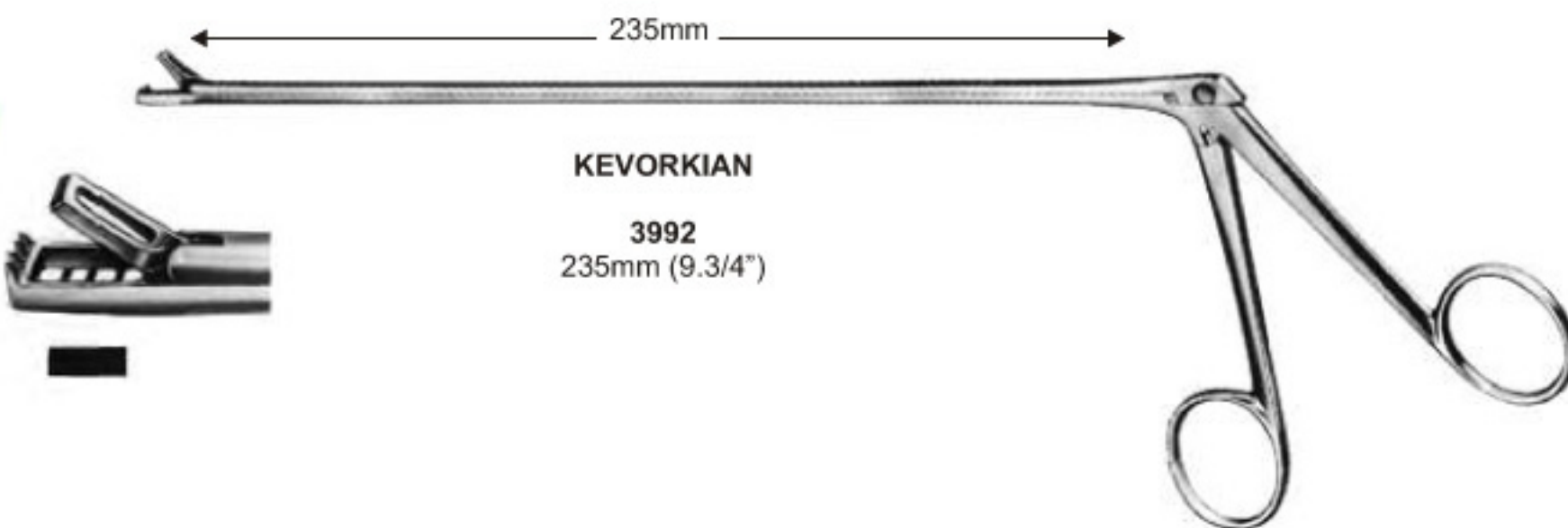

**KEVORKIAN**  
**3992**  
235mm (9.3/4")

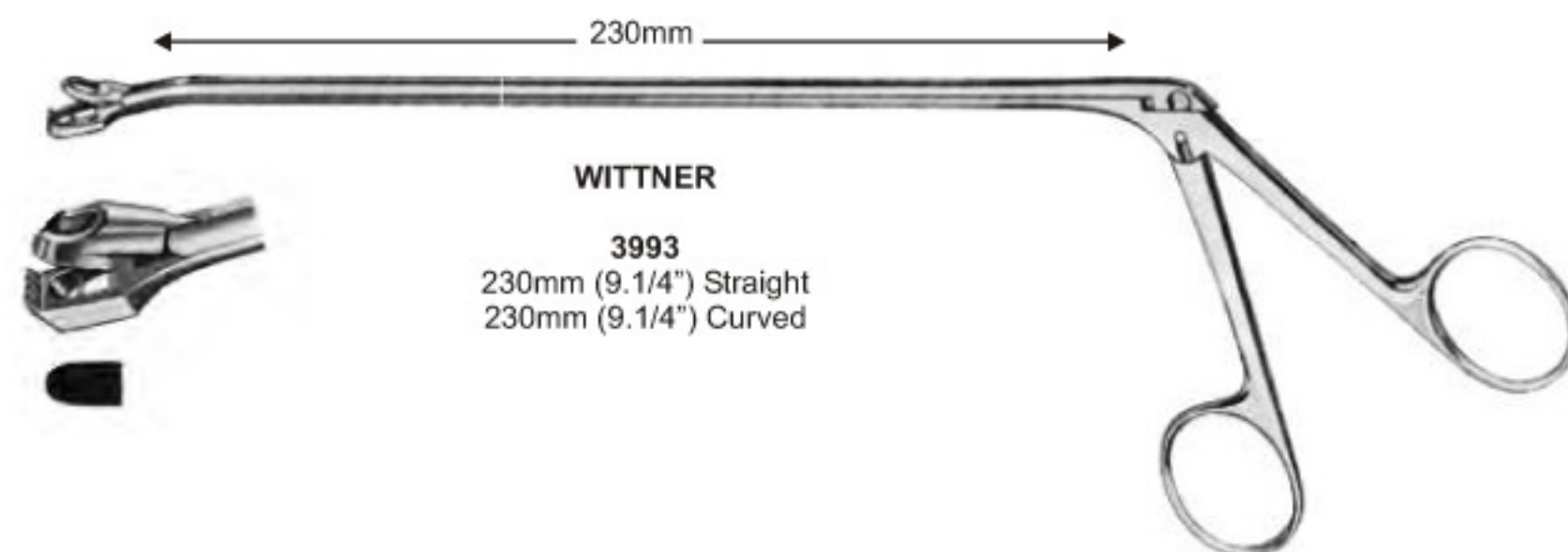

**WITTNER**  
**3993**  
230mm (9.1/4") Straight  
230mm (9.1/4") Curved

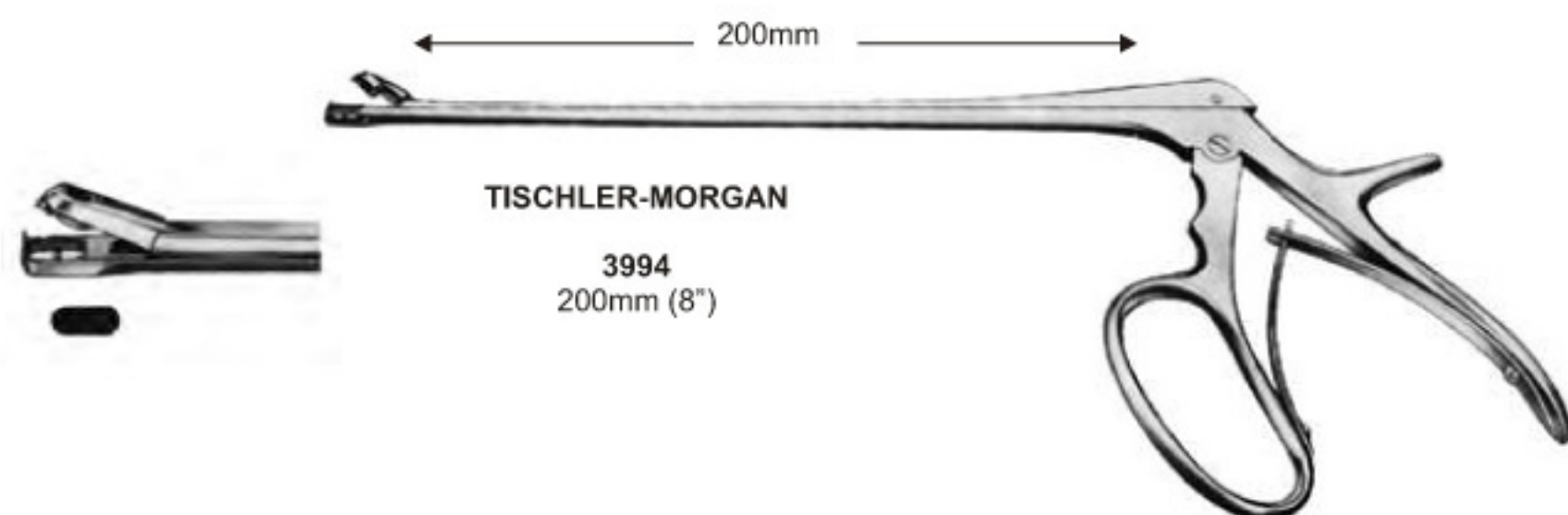

**TISCHLER-MORGAN**  
**3994**  
200mm (8")





OVAL  
7 x 5 mm

**BURKE**  
3995  
200mm (8")

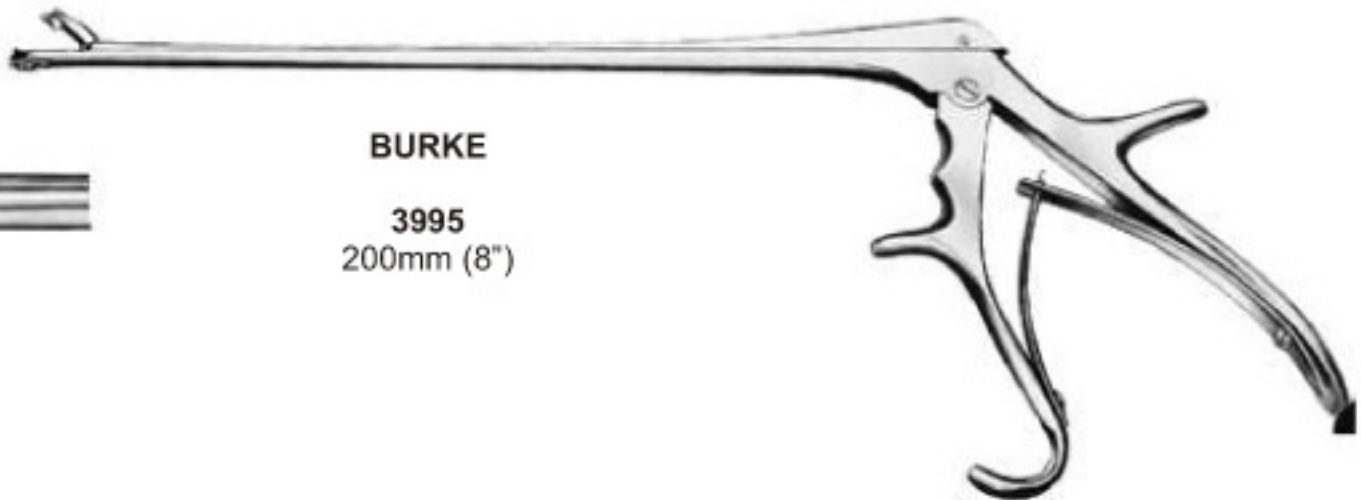

TISHLER-MORGAN

Fig.1



OVAL  
3.7 x 5mm

**TOWNSEND**  
3996  
250mm (10")

Fig.3

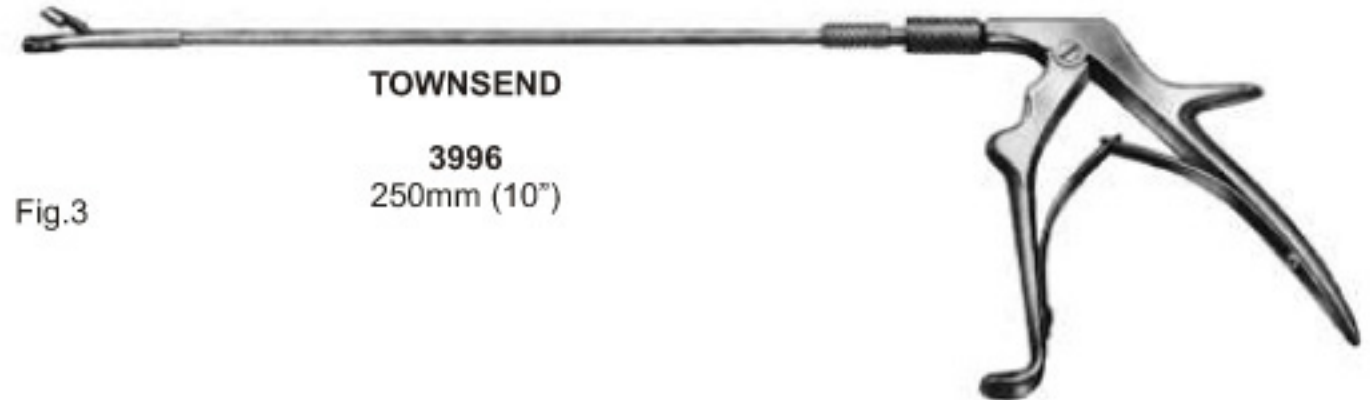

MINI

Fig.5



KEVORKIAN

Fig.4



3 x 8 mm

**KEVORKIAN**  
3997  
250mm (10")

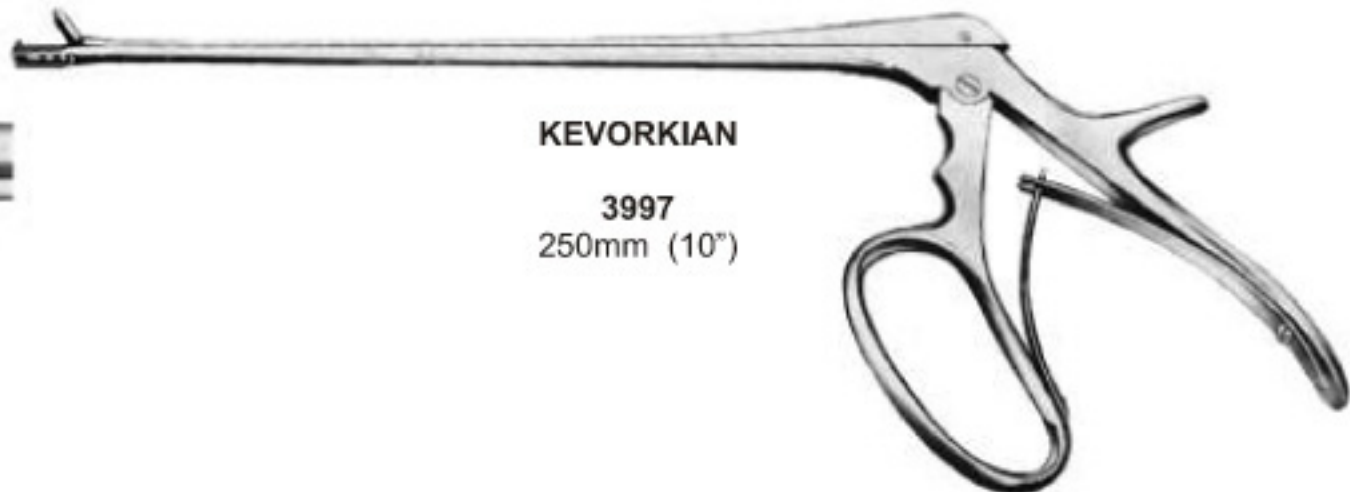





**DOYEN**  
**3998**  
185mm (7.1/4")



**3999**  
250mm (10")



**BONNEY POLYPI**  
**4000**  
240mm (9.1/2")





**HEYWOOD SMITH**

**4001**  
240mm (9.1/2")



**MCLINTOCK**

**4002**  
240mm (9.1/2")



**NOTO**

**4003**  
280mm (11")





**TUFNOL Mallet**  
250mm (10")

**4004**  
Diameter: 35mm

**4005**  
Diameter: 42mm

**4006**  
Diameter: 50mm



**4007**  
230mm (9")  
Diameter: 35mm



**4008**  
One metal disk, flat  
One metal disk, convex



**4009**  
One plastic disk, flat  
One Plastic disk, Convex



**4010**  
Wrench





**LUCAE**

**4011**  
Diameter: 27mm  
8.1/2 oz



**KELSEY FRY**

**4012**  
190mm (7.1/2")  
Diameter: 20mm

**SPARE DISKS**

**4013**  
Spare disks for  
Kelsey-Fry Mallet



**HEATH**

**4014**  
Diameter: 25mm  
28 oz

**4015**  
Diameter: 40mm  
36 oz







**SWEDISH MODEL CHISELS**  
200mm (8")  
Straight

- 4016**  
Width: 10mm
- 4017**  
Width: 15mm
- 4018**  
Width: 20mm
- 4019**  
Width: 25mm
- 4020**  
Width: 30mm

**CAPENER CHISELS**  
255mm (10")  
With Tufnal Handle  
Straight

- 4021**  
Width: 6mm
- 4022**  
Width: 8mm
- 4023**  
Width: 10mm
- 4024**  
Width: 12mm
- 4025**  
Width: 15mm
- 4026**  
Width: 20mm
- 4027**  
Width: 25mm
- 4028**  
Width: 30mm

**CAPENER CHISELS**  
255mm (10")  
With Tufnal Handle  
Curved

- 4029**  
Width: 6mm
- 4030**  
Width: 8mm
- 4031**  
Width: 10mm
- 4032**  
Width: 12mm
- 4033**  
Width: 15mm
- 4034**  
Width: 20mm
- 4035**  
Width: 25mm
- 4036**  
Width: 30mm

**SWEDISH MODEL OSTEOTOME**  
200mm (8")  
Straight

- 4037**  
Width: 10mm
- 4038**  
Width: 15mm
- 4039**  
Width: 20mm
- 4040**  
Width: 25mm
- 4041**  
Width: 30mm

**SMITH-PETERSON OSTEOTOME**  
200mm (8")  
Straight

- 4042**  
Width: 10mm
- 4043**  
Width: 15mm
- 4044**  
Width: 20mm
- 4045**  
Width: 25mm
- 4046**  
Width: 30mm



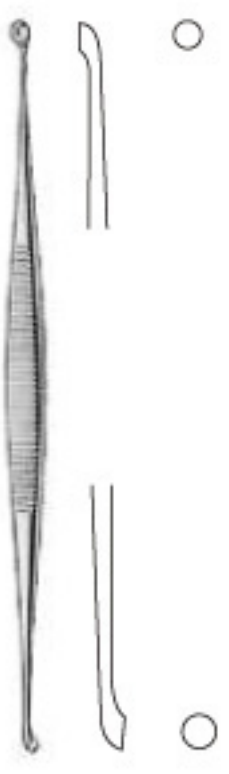
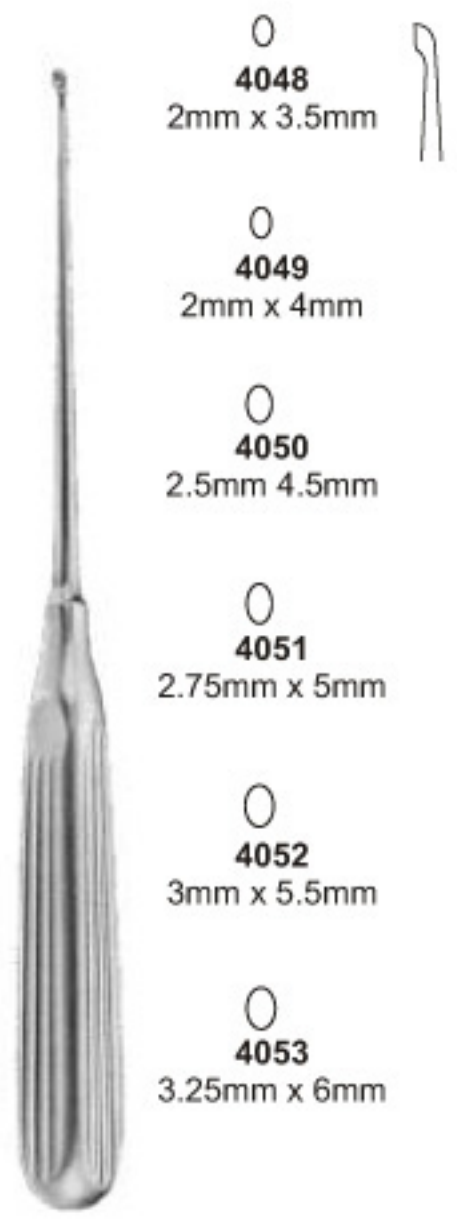
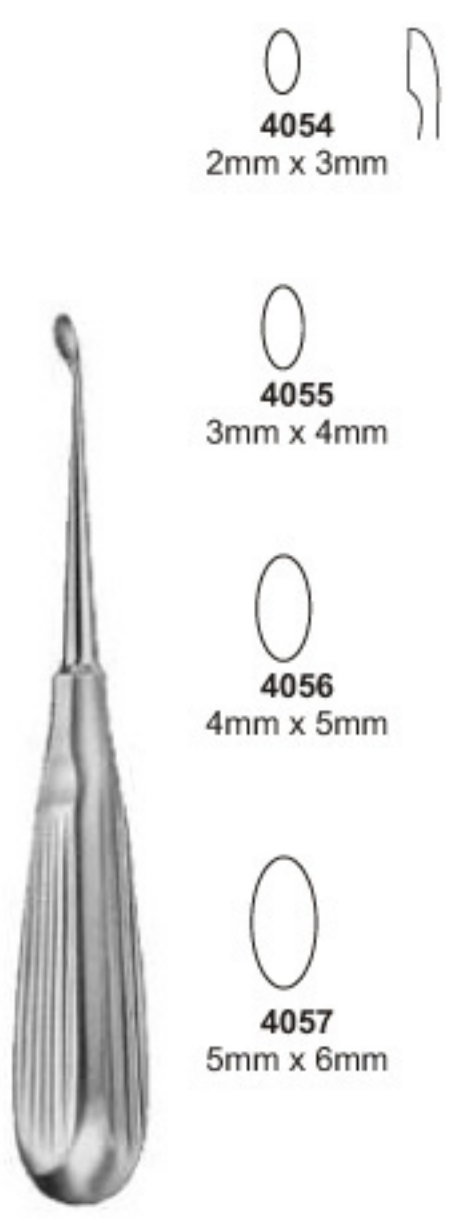

		
<p><b>MARTINI</b> <b>4047</b> 140mm (5.1/2")</p>	<p><b>LEMPERT</b> 200mm (8")*</p>	<p><b>COLLIER AND MORRIS</b> 180mm (7")</p>

<p>○ <b>4048</b> 2mm x 3.5mm</p>	<p>○ <b>4054</b> 2mm x 3mm</p>
<p>○ <b>4049</b> 2mm x 4mm</p>	<p>○ <b>4055</b> 3mm x 4mm</p>
<p>○ <b>4050</b> 2.5mm 4.5mm</p>	<p>○ <b>4056</b> 4mm x 5mm</p>
<p>○ <b>4051</b> 2.75mm x 5mm</p>	<p>○ <b>4057</b> 5mm x 6mm</p>
<p>○ <b>4052</b> 3mm x 5.5mm</p>	
<p>○ <b>4053</b> 3.25mm x 6mm</p>	





**VOLKMANN**  
170mm (6.3/4")

2.8mm	3.6mm	4.4mm	5.2mm	6.8mm
<b>4058</b>	<b>4059</b>	<b>4060</b>	<b>4061</b>	<b>4062</b>

8.5mm	10mm	11.5mm	13mm	14.5mm
<b>4063</b>	<b>4064</b>	<b>4065</b>	<b>4066</b>	<b>4067</b>

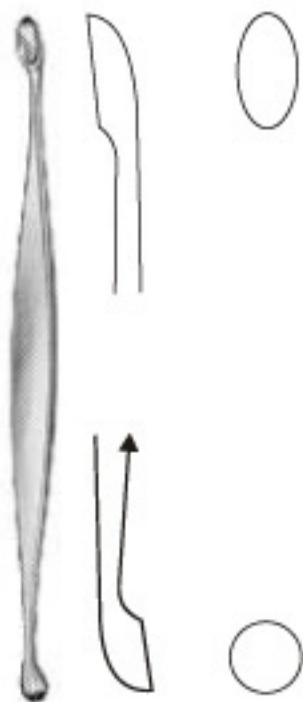

**BOYD  
BONE CURETTE**  
Oval, double ended  
**4068**  
130mm (5.1/8")

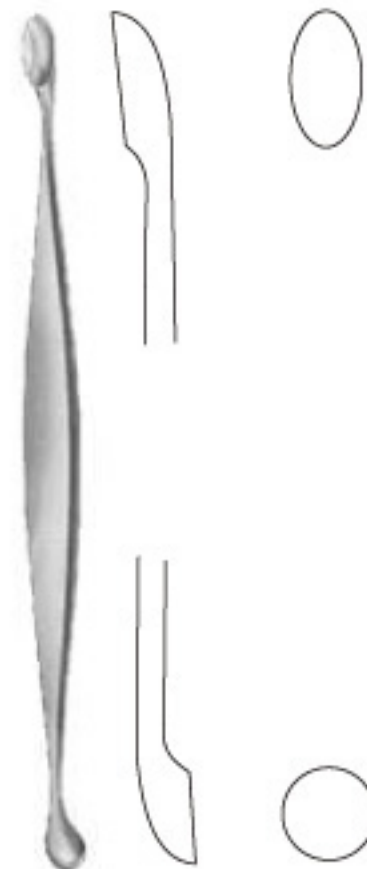

**BOYD  
BONE CURETTE**  
Oval, double ended  
**4069**  
160mm (6.1/4")

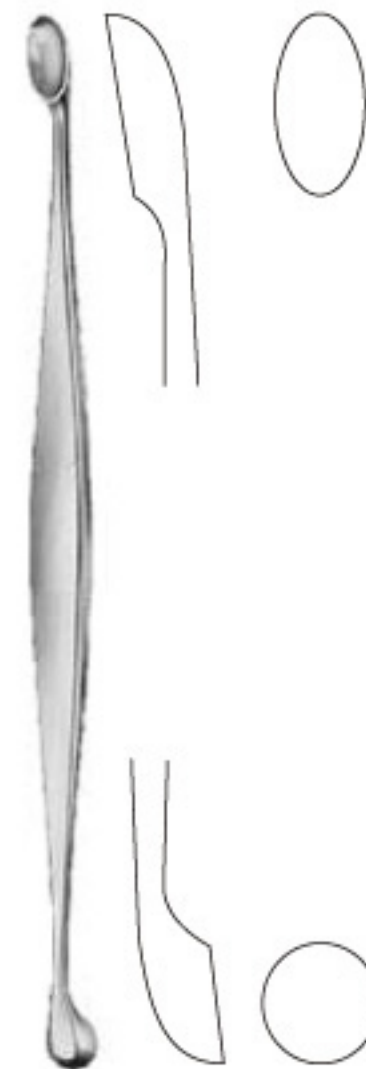

**BOYD  
BONE CURETTE**  
Oval, double ended  
**4070**  
200mm (8")



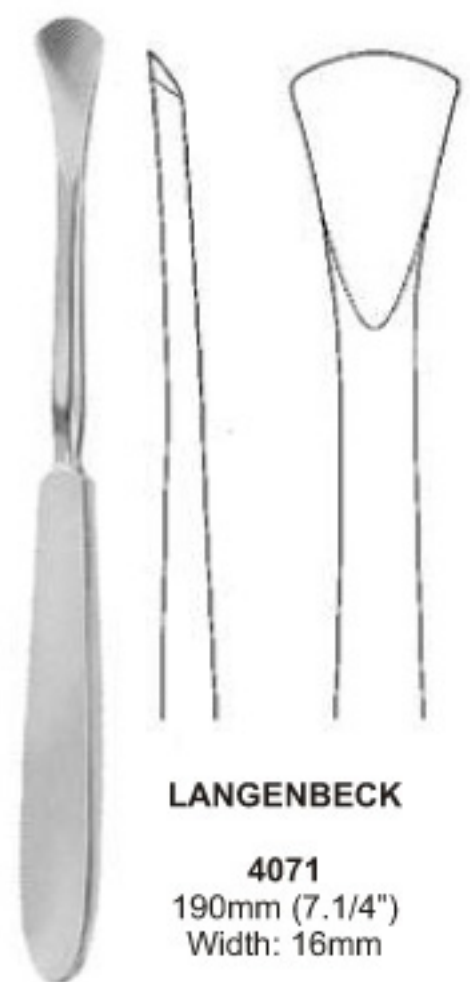

**LANGENBECK**  
**4071**  
190mm (7.1/4")  
Width: 16mm



**MCKISSOCK**  
**4072**  
195mm (7.3/4")

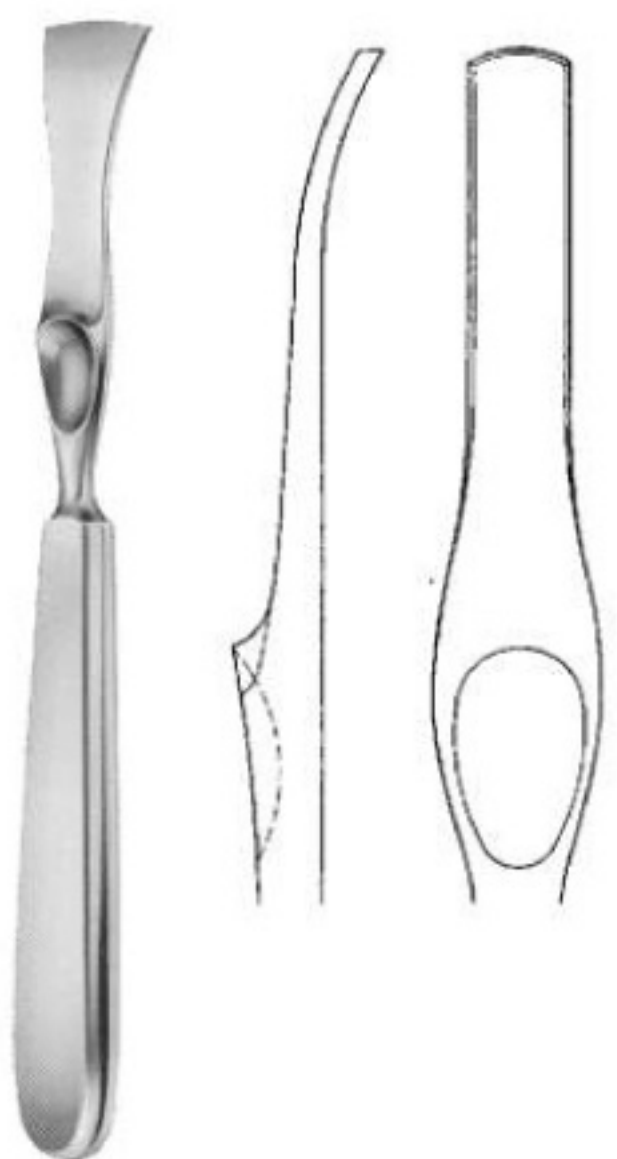

**LAMBOTE**  
215mm (8.1/2")  
**4073**  
Width: 5mm  
**4074**  
Width: 10mm  
**4075**  
Width: 15mm  
**4076**  
Width: 20mm  
**4077**  
Width: 25mm



**BRISTOW**  
**4078**  
230mm (9")





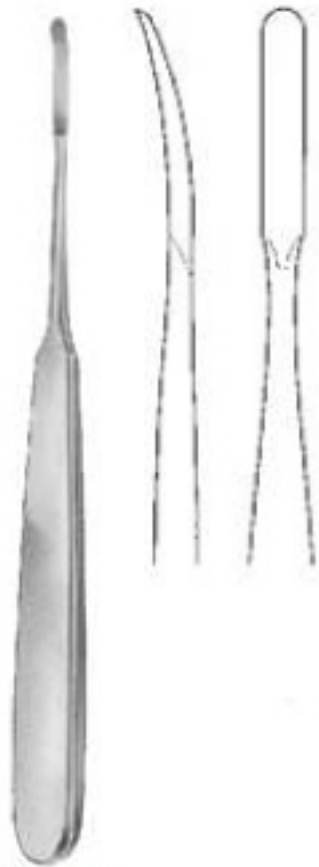

**JOSEPH**

**4079**  
170mm (6.3/4")  
Width at tip: 4mm



**MACDONALD**

**4080**  
185mm (7.1/4") blunt



**FREER ELEVATOR**

**4081**  
190mm (7.1/2"), double ended



**ADSON**

165mm (6.1/2"), curved

**4082** width 5mm  
**4083** width 7mm



**ADSON**

165mm (6.1/2") slight curve  
**4084** Width 7mm



**PENNYBACKER**

150mm (6")  
**4085** Width 6mm





**"COBRA"  
HIP LEVER**

**4086**  
235mm (9.1/4")  
Max Width: 65mm  
Width at tip: 25mm



**MINI-HOHMANN**

**4087**  
160mm (6.1/4")  
Max width: 6mm  
Width at tip: 2mm

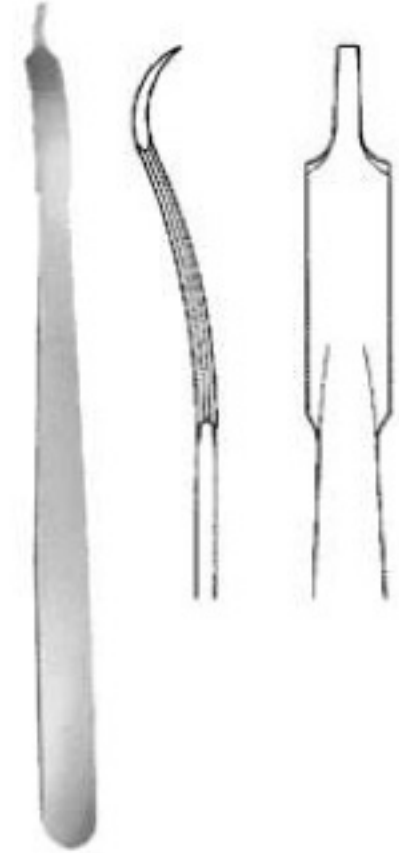

**MINI-HOHMANN**

**4088**  
160mm (6.1/4")  
Max width: 8mm  
Width at tip: 2mm

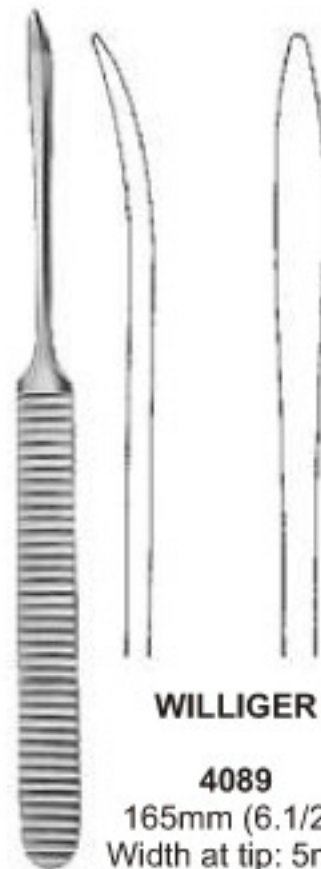

**WILLIGER**

**4089**  
165mm (6.1/2")  
Width at tip: 5mm

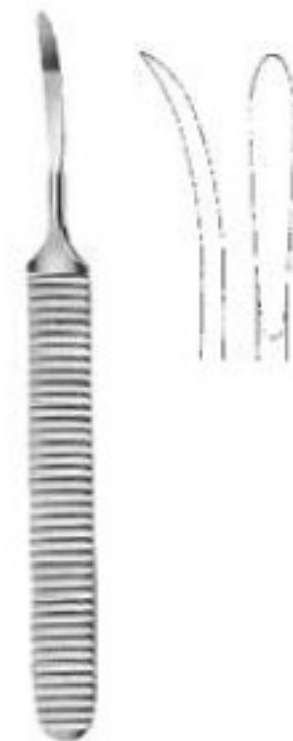

**WILLIGER**

**4090**  
140mm (4.1/2")  
Width at tip: 4mm



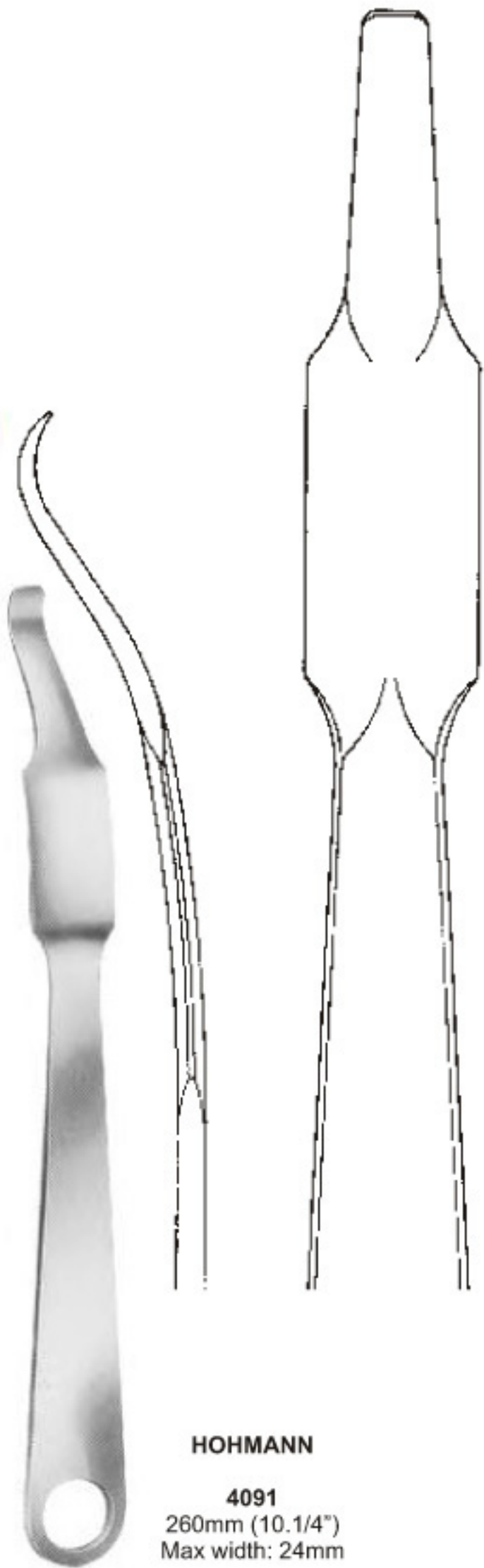

**HOHMANN**

**4091**  
260mm (10.1/4")  
Max width: 24mm

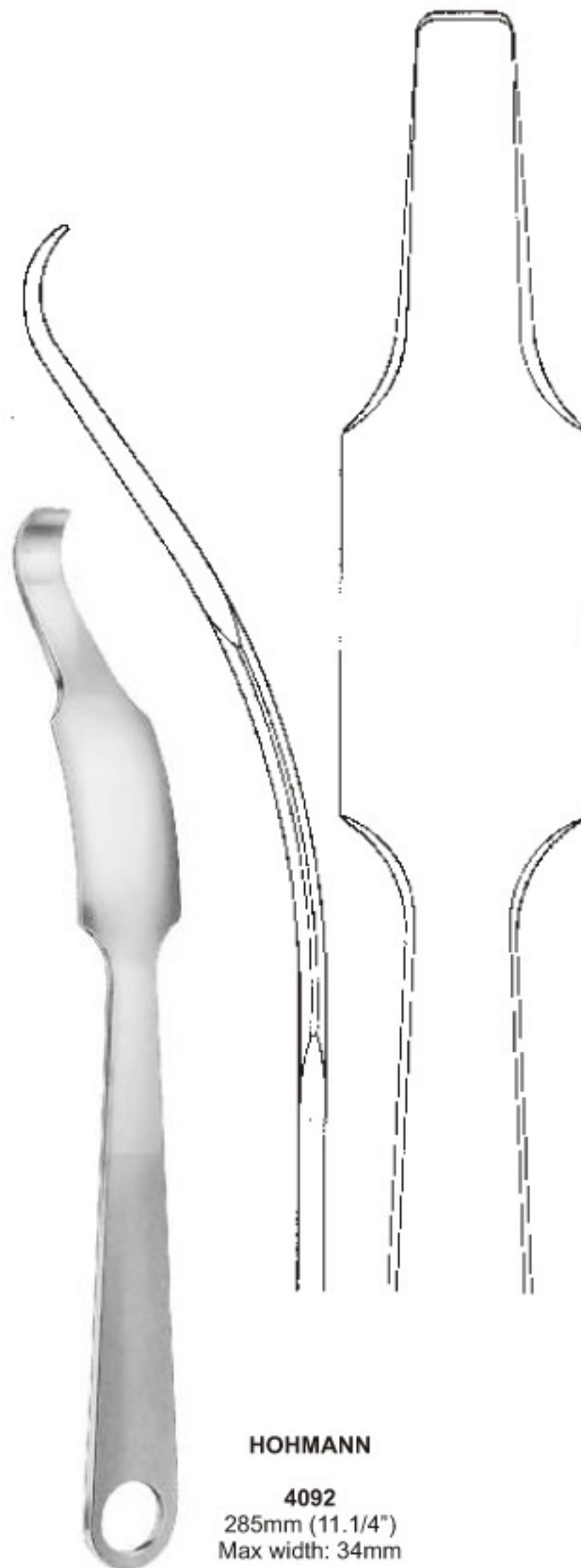

**HOHMANN**

**4092**  
285mm (11.1/4")  
Max width: 34mm





**ST THOMAS**



**4093**  
180mm (7")  
Pointed end

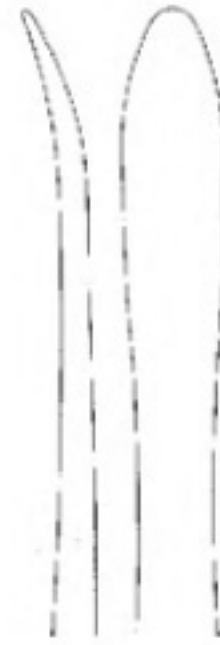

**4094**  
180mm (7")  
Rounded end



**CAIRNS SKULL FLAP ELEVATOR**

**4095**  
180mm (7")



**TRETHOWAN BONE LEVER**

**4096**  
215mm (8.1/2")



**LANE BONE LEVER**

**4097**  
255mm (10")







**PERCY AMPUTATION FLAP  
RETRACTOR**

**4098**  
Removable handles



**AMPUTATION SAW**  
With hinged back  
to take apart  
**4099**  
Blade: 230mm (9")

**5000**  
Spare blade for  
amputation saw



**FINGER SAW**  
**5001**  
200mm (8")



**ARMY REGULATION  
AMPUTATION SAW**

**5002**  
Blade: 180mm (7")  
With hinged back  
to take apart





**LISTON**

**5003**

Blade: 130mm (5.1/8")

**5004**

Blade 220mm (8.3/4")



**LANGENBECK**

**5005**

Resection knife

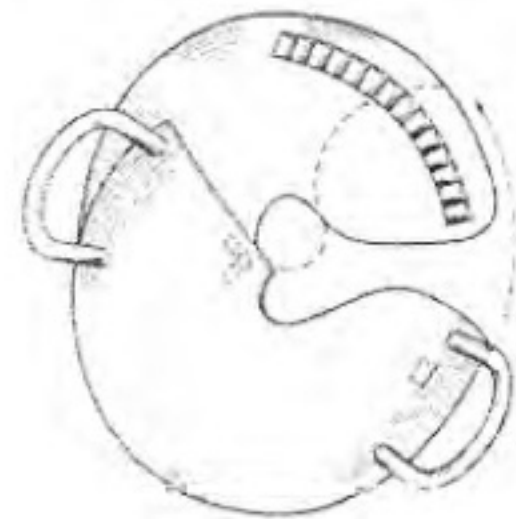

**BLAKE AMUPTATION FLAP  
RETRACTOR**

**5006**

Diameter: 240mm (9.1/2")



**FRAZIER**

**5007**

185mm (7.1/4") Diameter 2.33mm 7.f.g

**5008**

185mm (7.1/4") Diameter 2.66mm 8 f.g

**5009**

185mm (7.1/4") Diameter 3mm 9.f.g

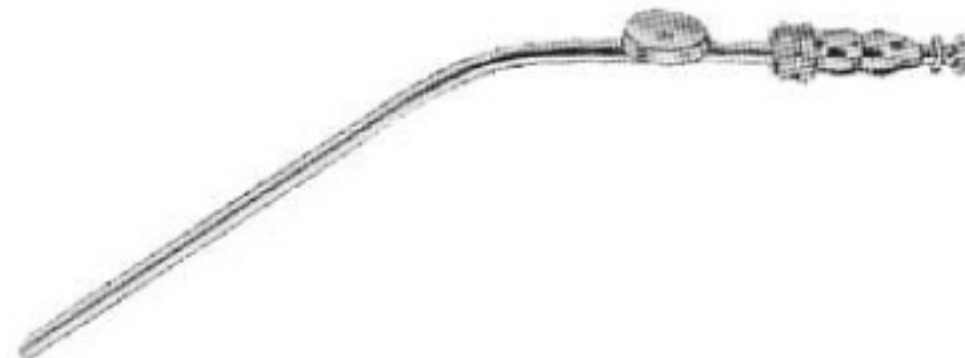

**ADSON FRAZIER**

180mm (7")

**5010** Diameter 2mm

**5011** Diameter 2.5mm

**5012** Diameter 3mm

**5013** Diameter 4mm

**5014** Diameter 5mm



**ADSON**

180mm (7")

**5015** Diameter 3mm

**5016** Diameter 5mm



**CONE SUCTION TUBES**

**5017**

Set comprising of one of each of the following items except 3498

**SUCTION TUBES**

**5018** Diameter: 3mm

**5019** Diameter: 4mm

**5020** Diameter: 5mm



**HANDLE**

**5021** 100mm (4")  
with Tucker valve





**BARRON**

**5022**  
230mm (9")  
Diameter: 1.33mm



**BELUCCI**

**5023**  
Set comprising of each of the following items:

**BELUCCI SUCTION TUBE**

**5024**  
170mm (6.3/4") Diameter: 2mm

**ZOELLNER DETACHABLE ENDS**

**5025** 20 s.w.g  
**5026** 22 s.w.g  
**5027** 24 s.w.g

**FORMBY**

**5028**  
210mm (8.1/4")  
Diameter: 3.3mm



**HOUSE**

Shaft: 90mm (3.1/2")  
Suction and irrigation tube

**5029**  
Diameter suction tube: 0.9mm  
Diameter irrigating tube: 0.7mm

**5030**  
Diameter suction tube: 1.2mm  
Diameter irrigating tube: 0.9mm

**5031**  
Diameter suction tube: 1.5mm  
Diameter irrigating tube: 1.2mm





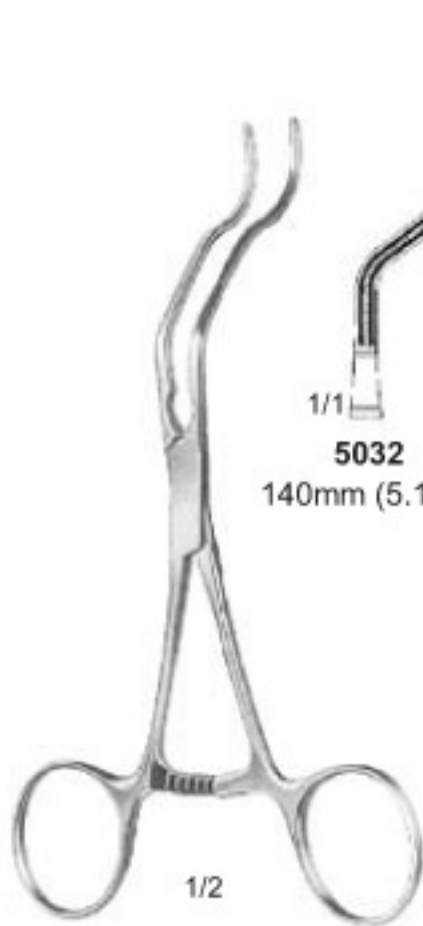

**GREGORY**

**5032**  
140mm (5.1/2")



**5033**  
160mm (6.1/4")

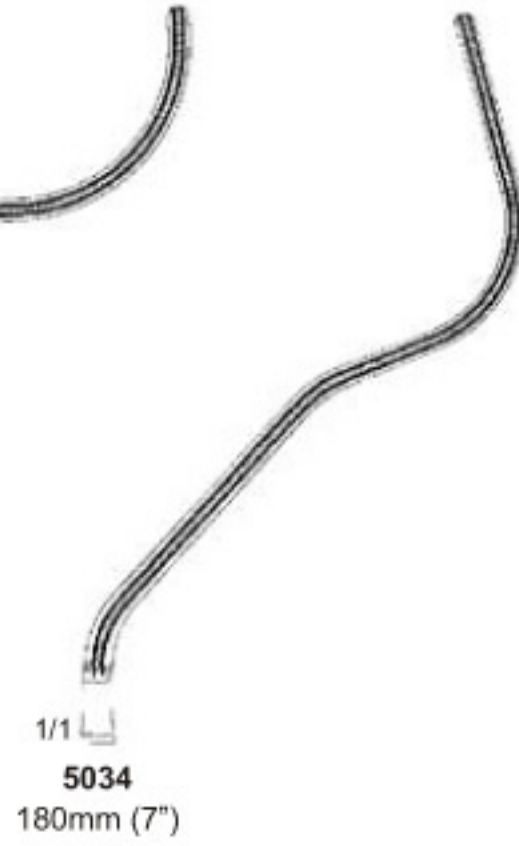

**5034**  
180mm (7")

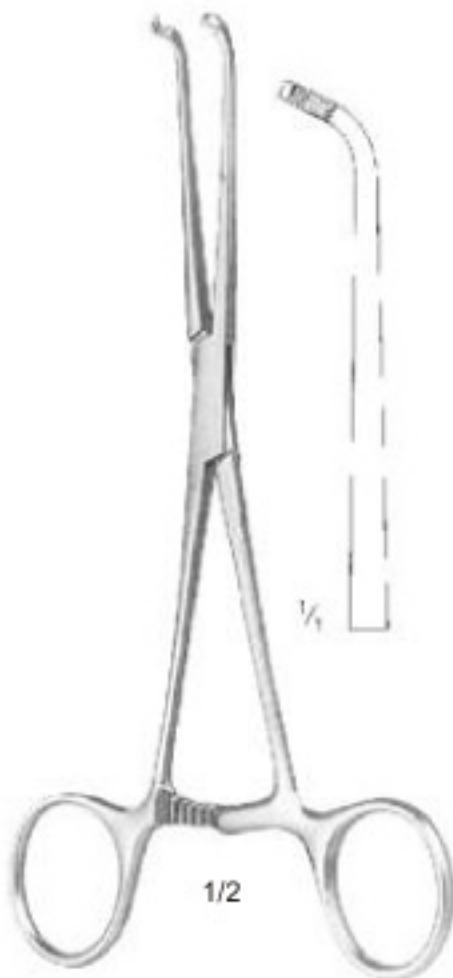

**JAVID**  
**5035**  
180mm (7")

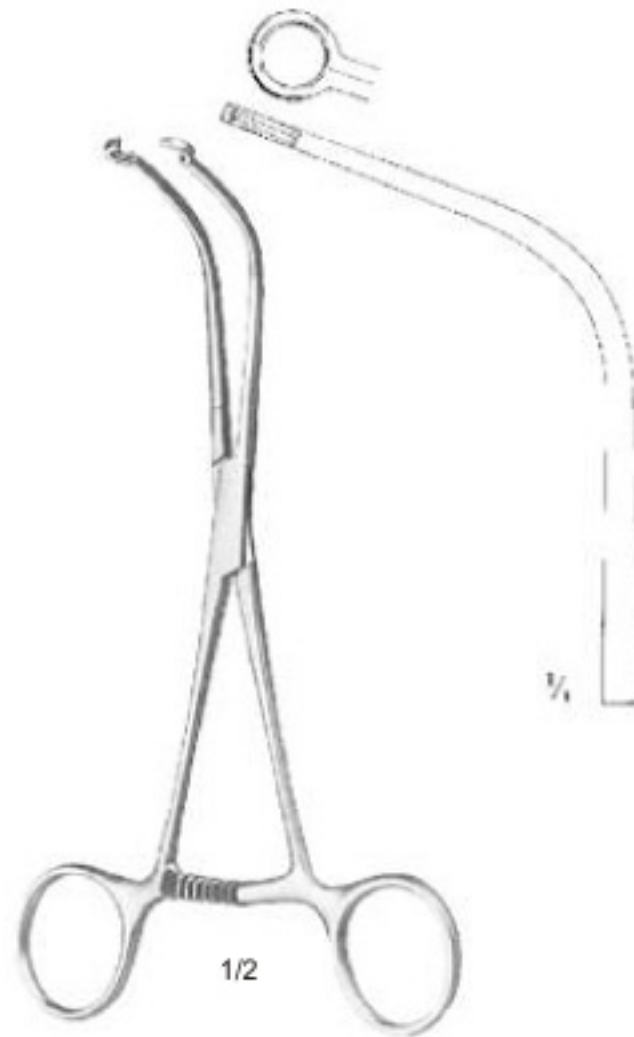

**JAVID**  
**5036**  
190mm (7.1/2")





1/2  
**DALE**  
**5037**  
185mm (7")

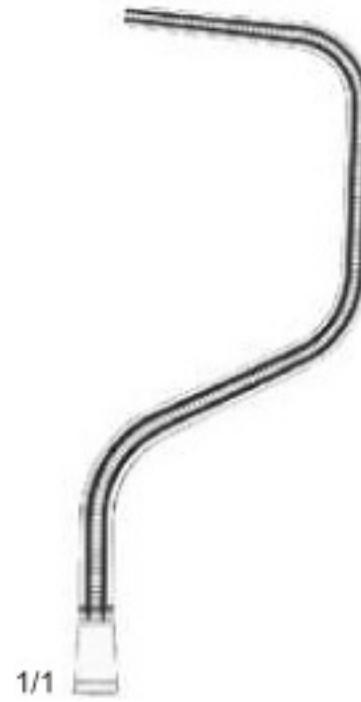

1/1



1/2  
**DALE**



1/1  
**5038**  
170mm (6.1/2")



1/1  
**5039**  
175mm (7")



1/1  
**5040**  
185mm (7.1/4")



1/1

**DE-BAKEY SATINSKY**

**5041**  
70mm (2.3/4")



1/1

**DE BAKEY-CAROTIS**

**5042**  
90mm (3.1/2")

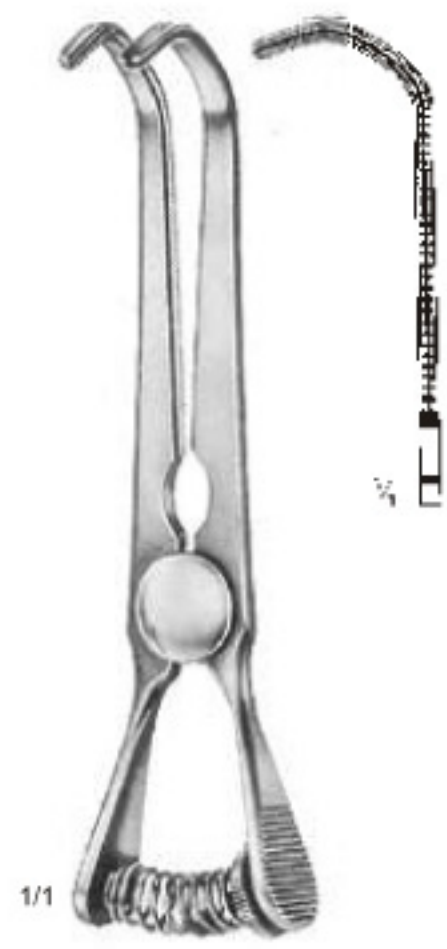

1/1

**DE BAKEY SATINSKY**

**5043**  
100mm (4")



1/1

**GLOVER**

**5044**  
50mm (2")



1/1

**SANTULLI**

**5045**  
70mm (2.3/4")

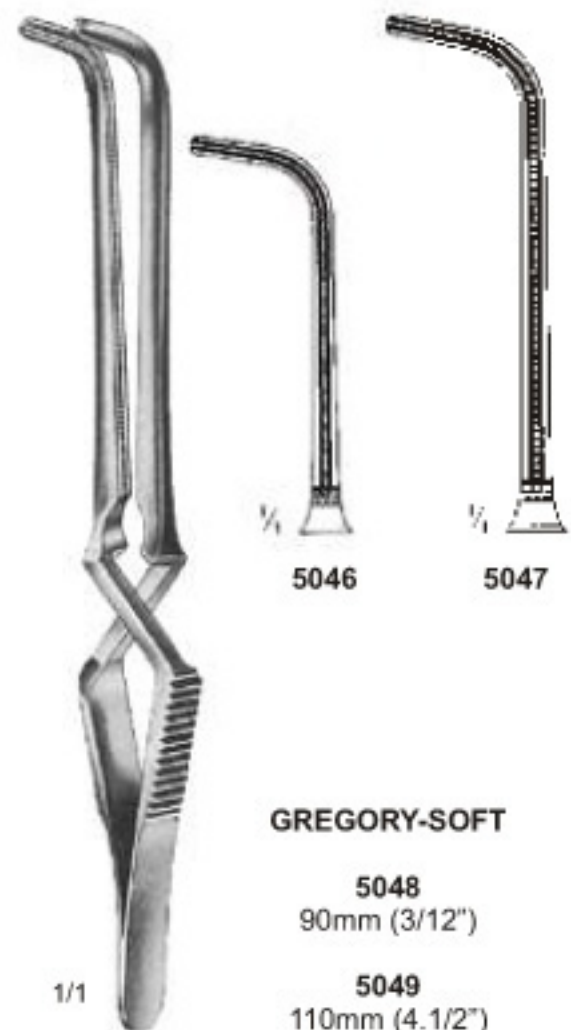

1/1

**GREGORY-SOFT**

**5048**  
90mm (3/12")

**5049**  
110mm (4.1/2")





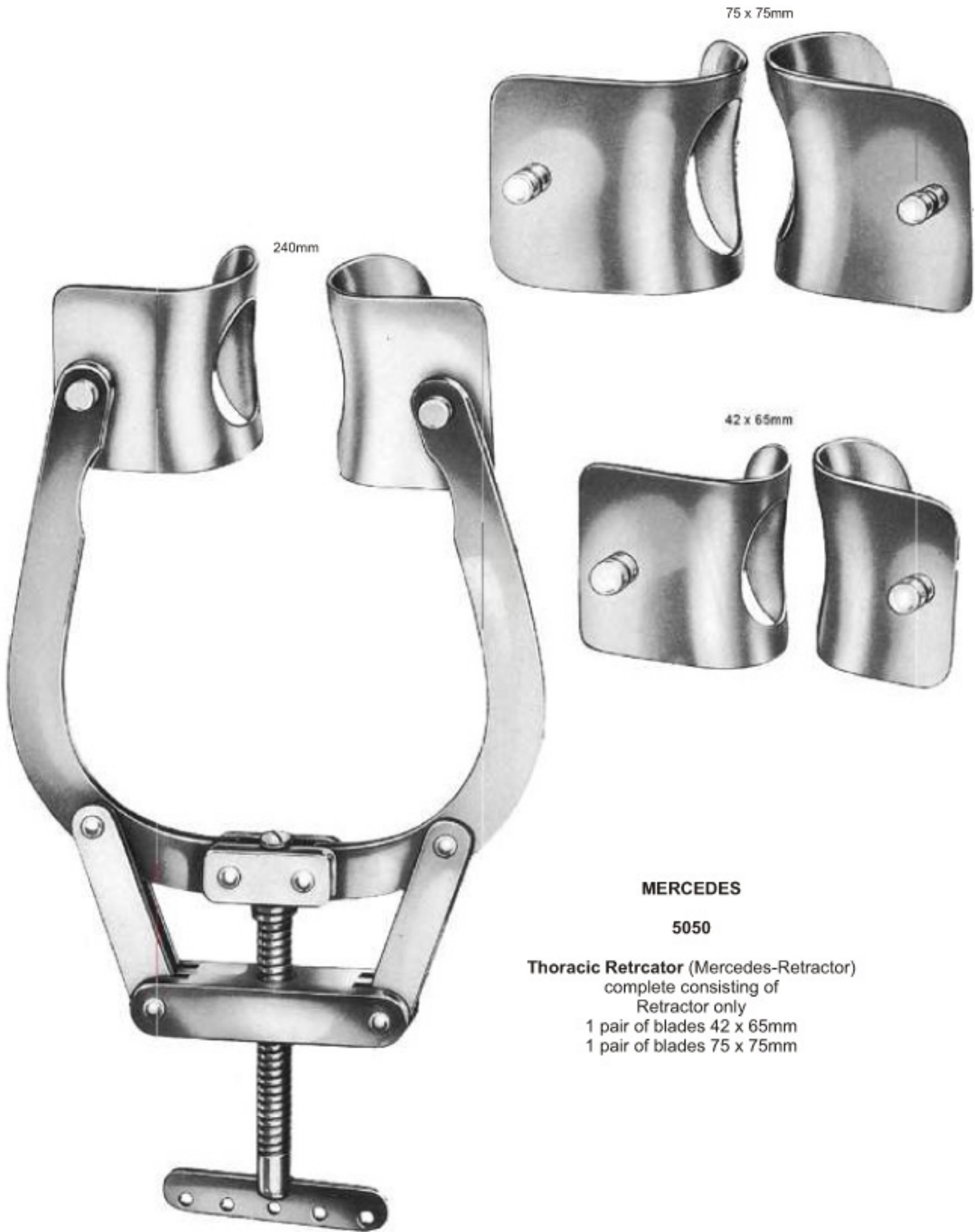

**MERCEDES**

**5050**

**Thoracic Retractor (Mercedes-Retractor)**  
complete consisting of  
Retractor only  
1 pair of blades 42 x 65mm  
1 pair of blades 75 x 75mm





# RIB SPREADERS

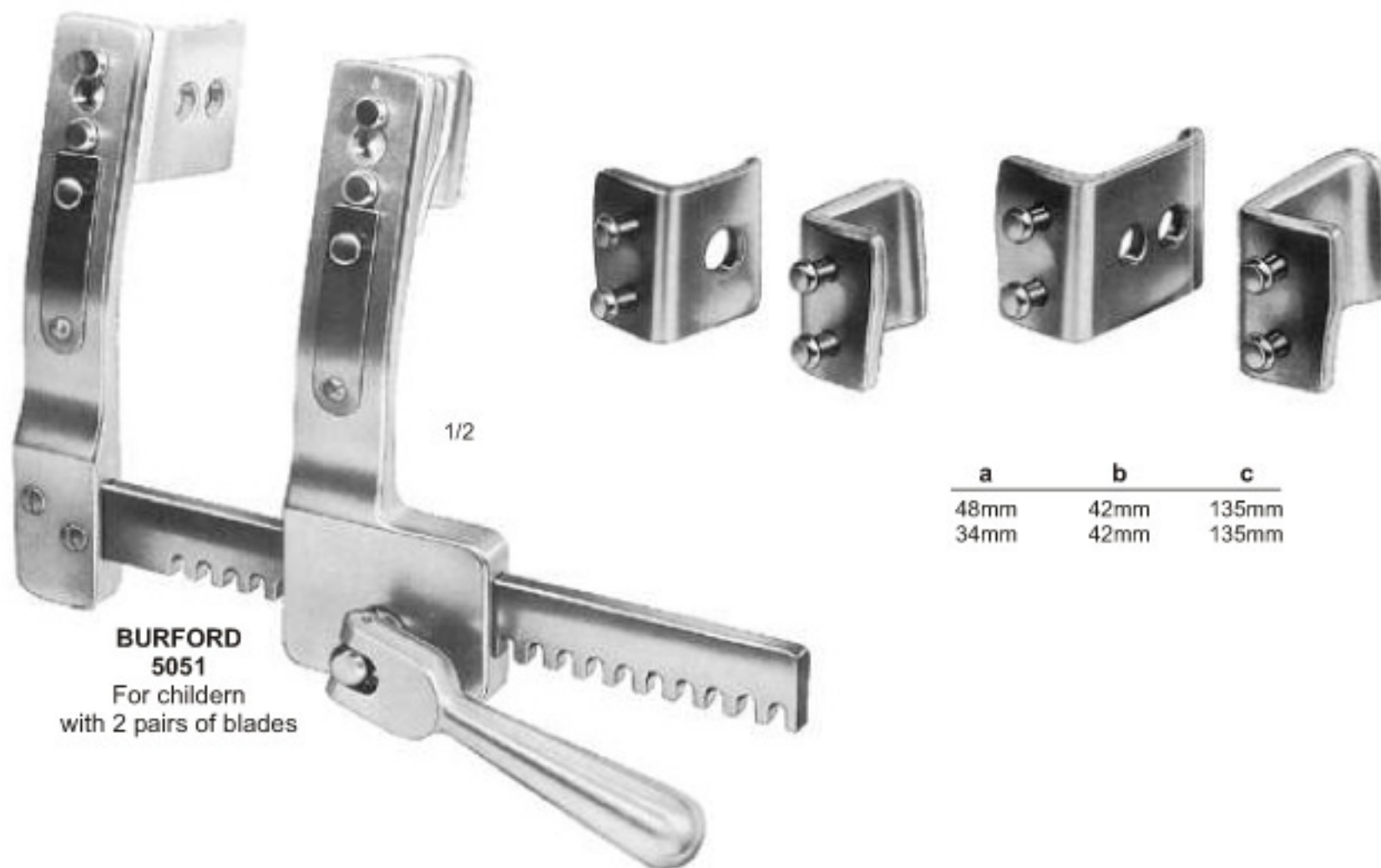

**BURFORD 5051**  
For children  
with 2 pairs of blades

a	b	c
48mm	42mm	135mm
34mm	42mm	135mm



**BURFORD 5052**  
for adults  
with pairs of blades

a	b	c
64mm	62mm	180mm
47mm	62mm	
65mm	62mm	260mm
47mm	62mm	
65mm	62mm	300mm
47mm	62mm	



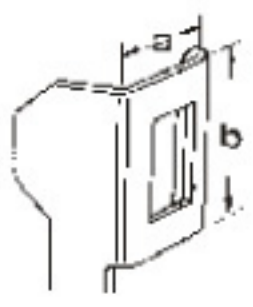

**COOLEY**

**5053**  
For new borns

A	B	C
12 mm	16 mm	95 mm

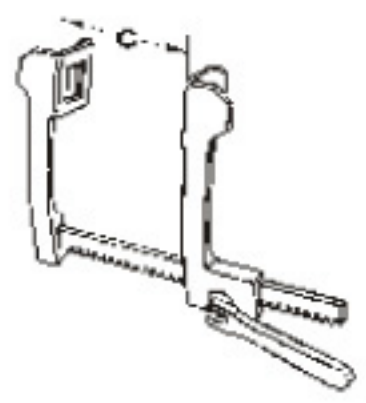

**COOLEY**

**5054**  
Pediatric size

A	B	C
15 mm	30 mm	140 mm
21 mm	44 mm	150 mm



**COOLEY**

**5055**  
For adults

A	B	C
35 mm	50 mm	200 mm



# BONE & RIB SHEARS



**5056**  
230mm (9")



**5057**  
220mm(8.3/4")



**5058**  
170mm (6.3/4")



**GLUCK**  
**5059**  
220mm (8.3/4")

With eccentric sliding blade



**STILLE**  
**5060**  
210mm (8.1/4")







**PLASTER SHEARS**  
**5061**  
160mm (6.1/4")



**PLASTER SHEARS**  
**5062**  
200mm (8")  
**5063**  
230mm (9")



**PLASTER SHEARS**  
**5064**  
235mm (9.1/4")



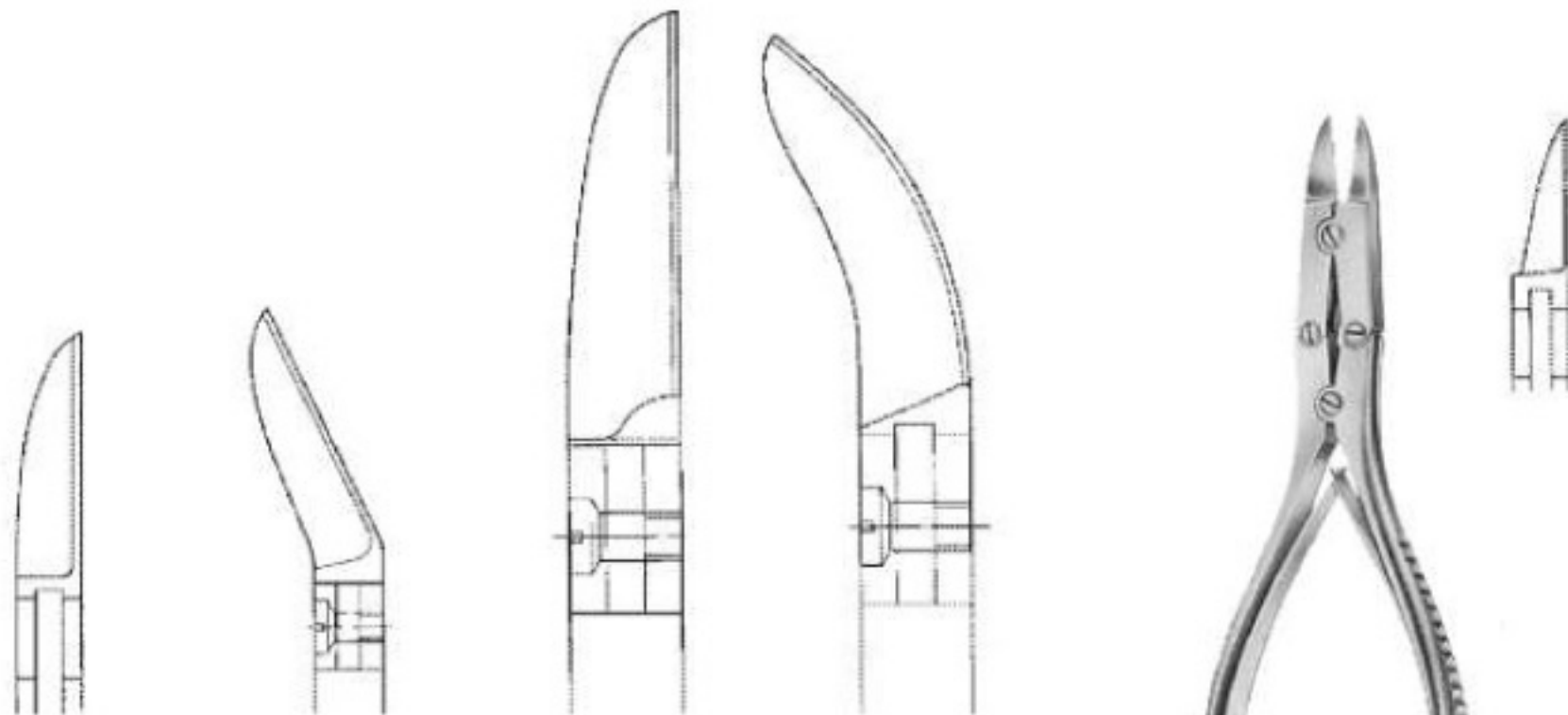

**5069**  
150mm (6")



**RUSKIN - LISTON**

**5065**  
190mm (7.1/2")  
Straight

**5066**  
190mm (7.1/2")  
Angled on flat



**STILLE  
LISTON**

**5067**  
280mm (11")  
Straight

**5068**  
275mm (10.3/4")  
Curved on flat



**5070**  
145mm (5.3/4")





**BECK RONGEUR**

**5071**  
Shaft: 130mm (5.1/8")  
2mm bite



**CUSHING (CAIRNS) RONGEUR**

Shaft: 130mm (5.1/8")

**5072**  
4mm bite

**5073**  
5mm bite

**5074**  
7mm bite



**CUSHING RONGEURS**  
Shaft: 130mm (5.1/8")

**5075**  
3mm bite

**5076**  
4mm bite

**5077**  
5mm bite



**CUSHING RONGEURS**  
Shaft 130mm (5.1/8")

**5078**  
3mm bite

**5079**  
4mm bite





**SARGENT (VAN HAVRE)**

**5080**  
220mm (8.3/4")  
10mm bite



**OLIVECRONA**

**5081**  
230mm (9")  
6mm bite



**STILLE-RUSKIN**

**5082**  
240mm (9.1/2")







**PENNYBACKER**  
**5083**  
200mm (8")  
4mm bite



**WILMS**  
**5084**  
200mm (8")  
4mm bite



**HEANLEY**  
**5085**  
175mm (7")  
4mm bite



**TROTTER**  
**5086**  
200mm (8")  
10mm bite



**KILLEARN**  
**5087**  
197mm (7.3/4")  
3mm bite



**LEKSELL**  
**5088**  
240mm  
(9.1/2")  
6mm bite  
**5089**  
240mm  
(9.1/2")  
8mm bite







**BEYER**  
**5090**  
150mm (6")  
5mm bite



**JANSEN-MIDDLETON  
SEPTUM FORCEPS**  
**5091**  
200mm (8") Spoon shaped  
4mm bite



**CAIRNS**  
**5092**  
140mm (5.1/2")  
4mm bite



**CAIRNS**  
**5093**  
140mm (5.1/2")  
4mm bite



**LUER**  
**5094**  
155mm (6")



**RUSKIN**  
**5095**  
190mm (7.1/2")  
6mm bite





**5096**  
250mm (9.3/4")



**5097**  
255mm (10")



**5098**  
175mm (7")

**VERBRUGGE**



**VERBRUGGE**



**5099**  
265mm (10.1/2")



**LEWIN**

**6000**  
135mm (5.1/4")



**6001**  
Complete Set

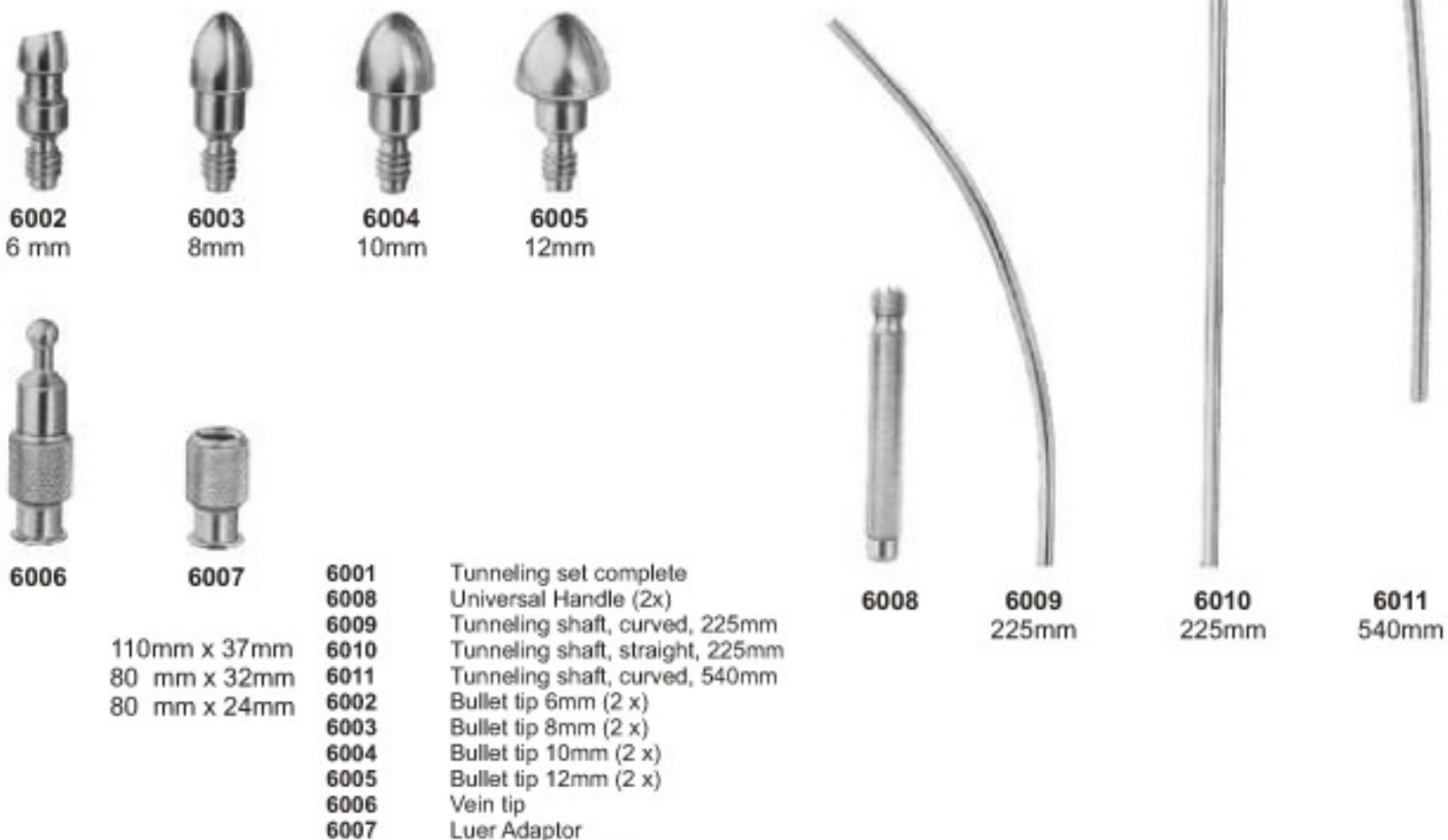

**6002**  
6 mm

**6003**  
8mm

**6004**  
10mm

**6005**  
12mm

**6006**

**6007**

110mm x 37mm  
80 mm x 32mm  
80 mm x 24mm

**6001** Tunneling set complete  
**6008** Universal Handle (2x)  
**6009** Tunneling shaft, curved, 225mm  
**6010** Tunneling shaft, straight, 225mm  
**6011** Tunneling shaft, curved, 540mm  
**6002** Bullet tip 6mm (2 x)  
**6003** Bullet tip 8mm (2 x)  
**6004** Bullet tip 10mm (2 x)  
**6005** Bullet tip 12mm (2 x)  
**6006** Vein tip  
**6007** Luer Adaptor  
Plate for tips only  
Sterilizing cases 550 x 115 x 35mm

**6008**

**6009**  
225mm

**6010**  
225mm

**6011**  
540mm



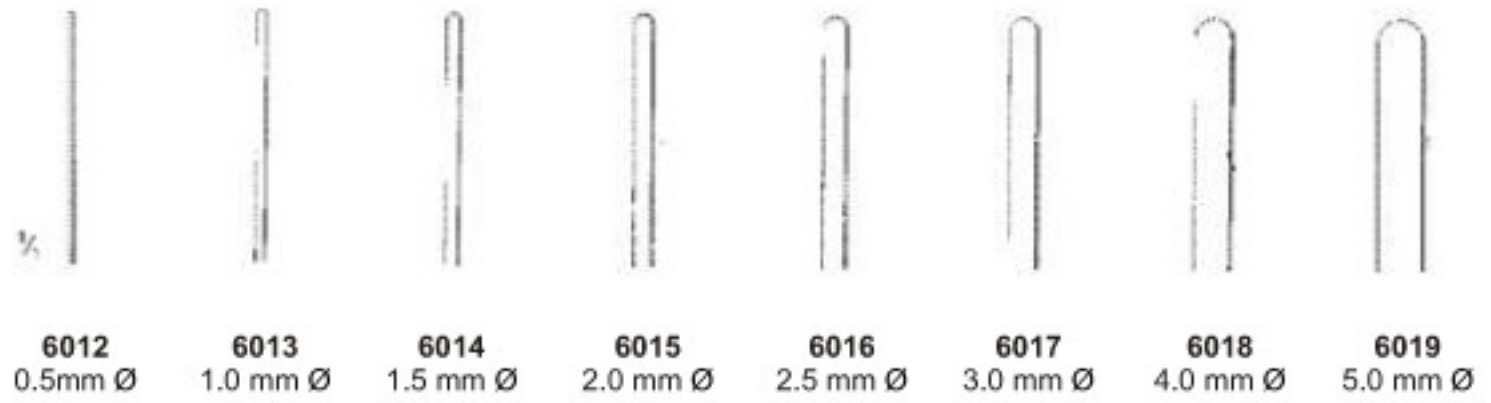

<b>6012</b> 0.5mm Ø	<b>6013</b> 1.0 mm Ø	<b>6014</b> 1.5 mm Ø	<b>6015</b> 2.0 mm Ø	<b>6016</b> 2.5 mm Ø	<b>6017</b> 3.0 mm Ø	<b>6018</b> 4.0 mm Ø	<b>6019</b> 5.0 mm Ø
------------------------	-------------------------	-------------------------	-------------------------	-------------------------	-------------------------	-------------------------	-------------------------

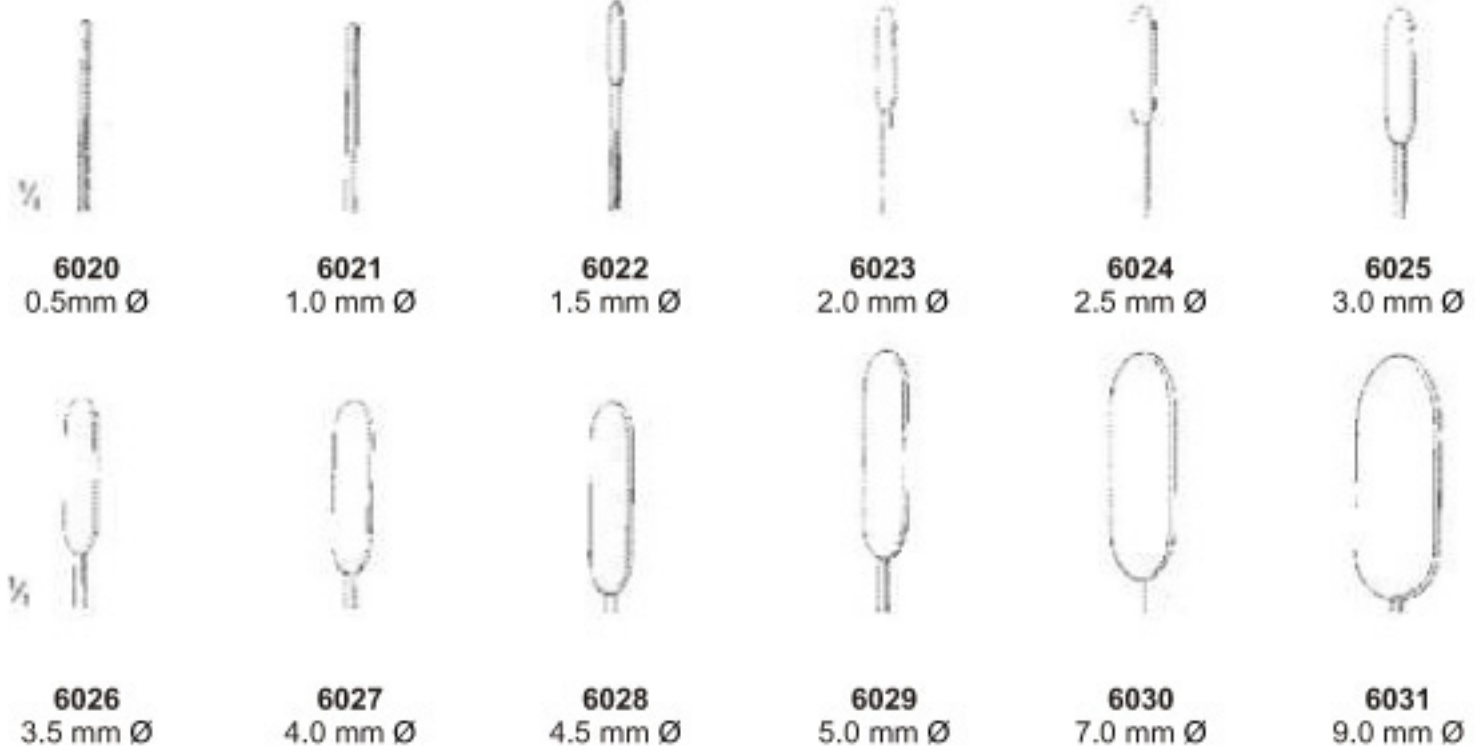

<b>6020</b> 0.5mm Ø	<b>6021</b> 1.0 mm Ø	<b>6022</b> 1.5 mm Ø	<b>6023</b> 2.0 mm Ø	<b>6024</b> 2.5 mm Ø	<b>6025</b> 3.0 mm Ø
<b>6026</b> 3.5 mm Ø	<b>6027</b> 4.0 mm Ø	<b>6028</b> 4.5 mm Ø	<b>6029</b> 5.0 mm Ø	<b>6030</b> 7.0 mm Ø	<b>6031</b> 9.0 mm Ø





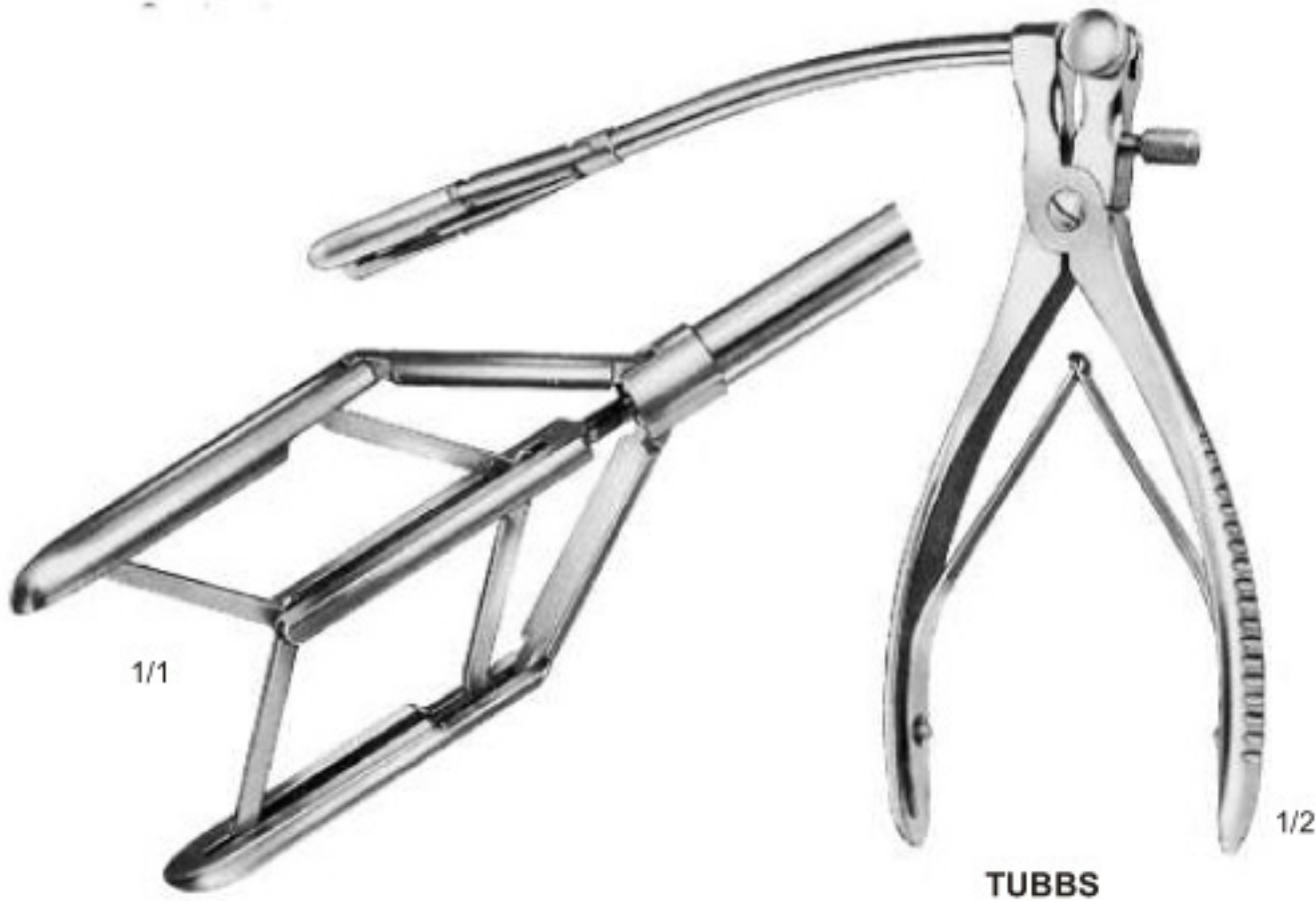

1/1

1/2

**TUBBS  
6032**  
Blade opening from 8 to 42mm

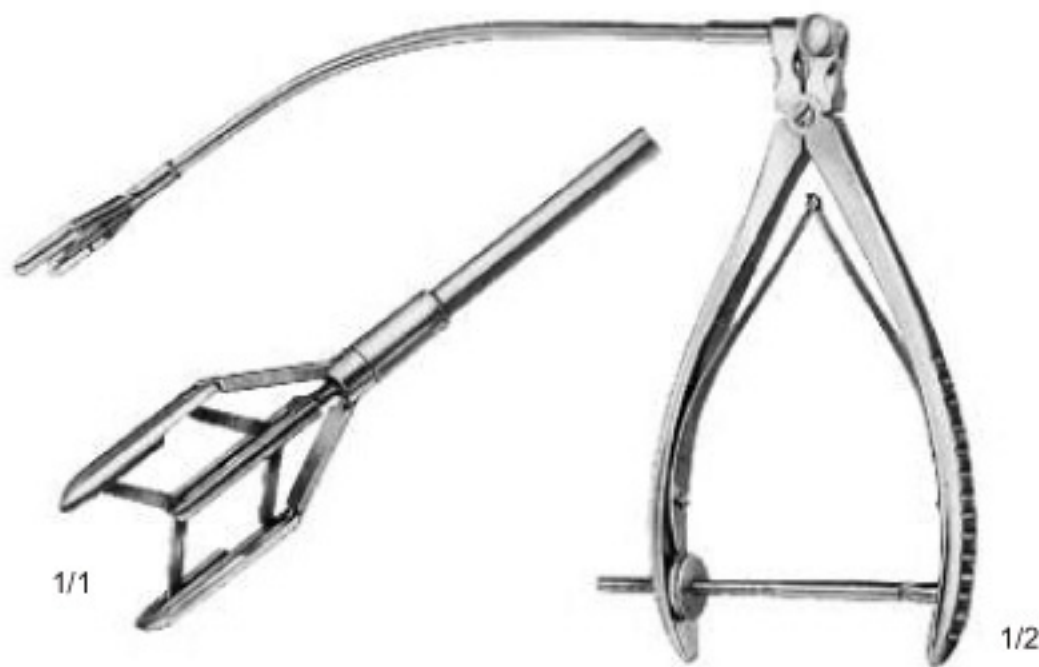

1/1

1/2

**COOLEY  
6033**  
Blade opening from 8 to 15mm



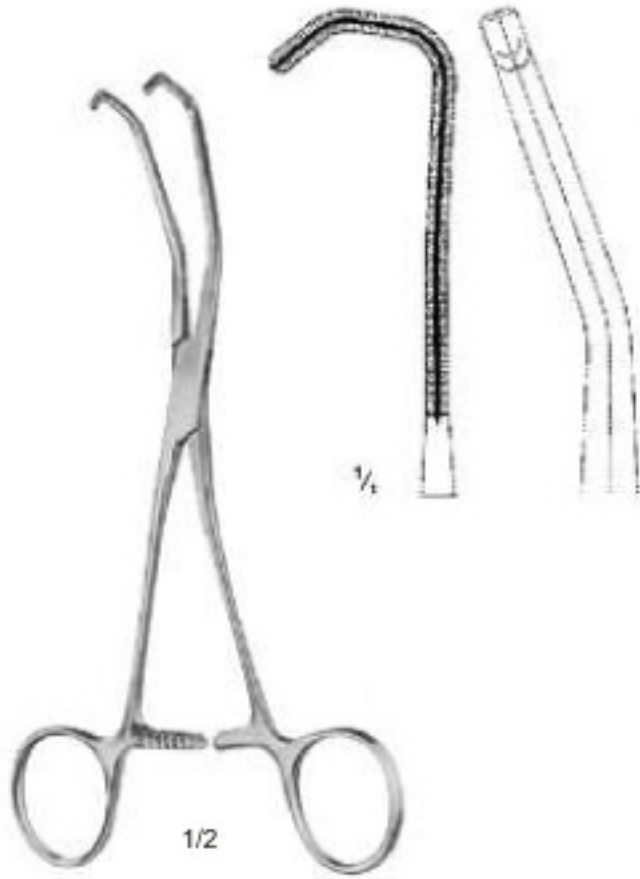

**COOLEY**  
**6034**  
170mm (6.3/4")



**COOLEY**  
**6035**  
160mm (6.1/4")



**COOLEY**  
**6036**  
150mm (6")

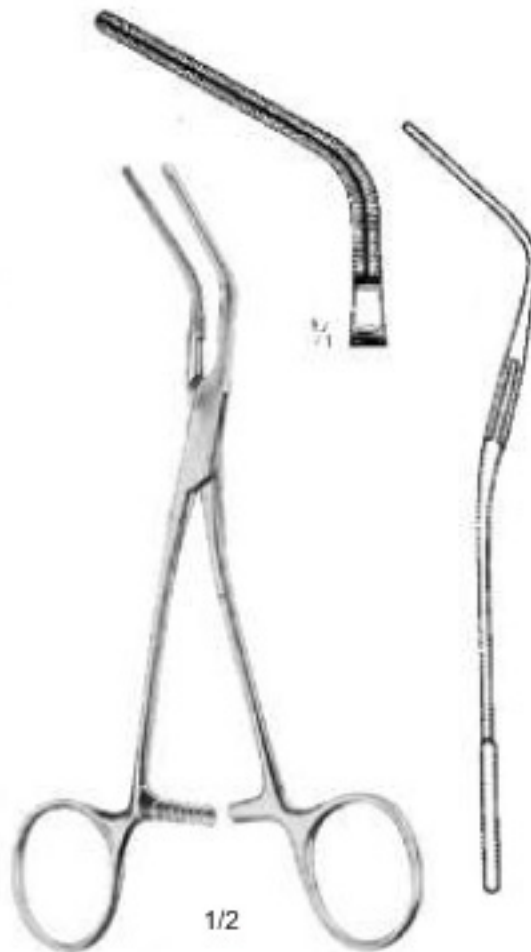

**COOLEY**  
**6037**  
155mm (6.1/4")

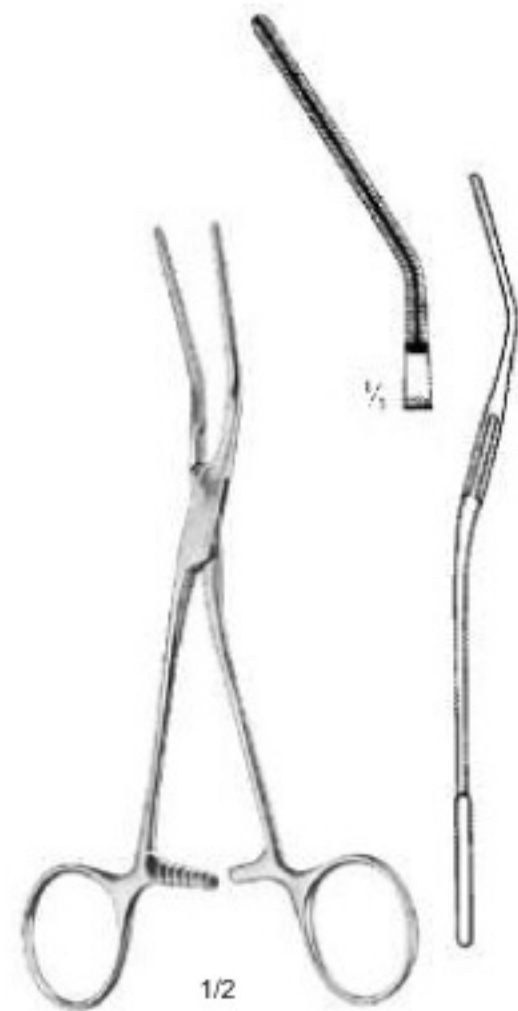

**COOLEY**  
**6038**  
170mm (6.3/4")



**DE BAKEY  
6039**  
100mm (4")

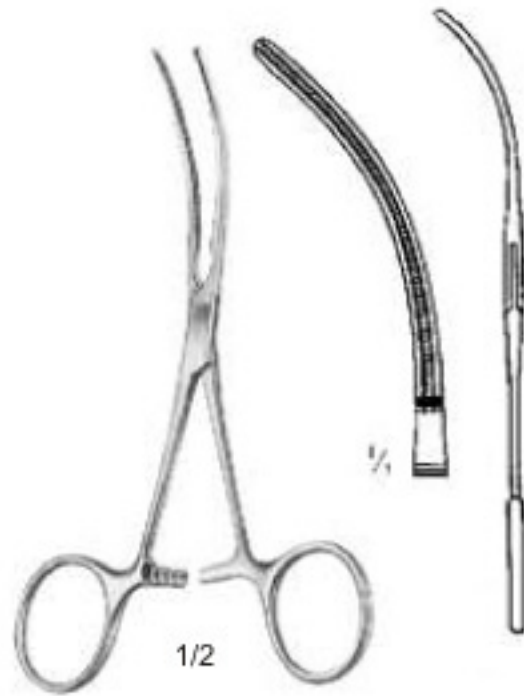

**DE BAKEY  
6040**  
110mm (4.1/4")

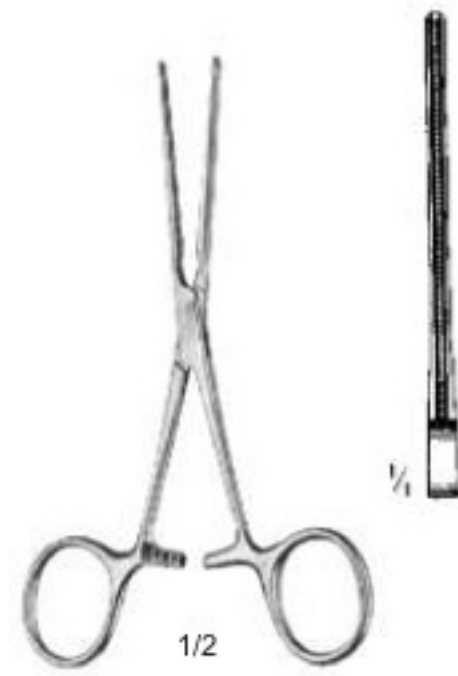

**DE BAKEY  
6041**  
120mm (4.3/4")



**DE BAKEY  
6042**  
120mm (4.3/4")



**DE BAKEY  
6043**  
130mm (5.1/4")





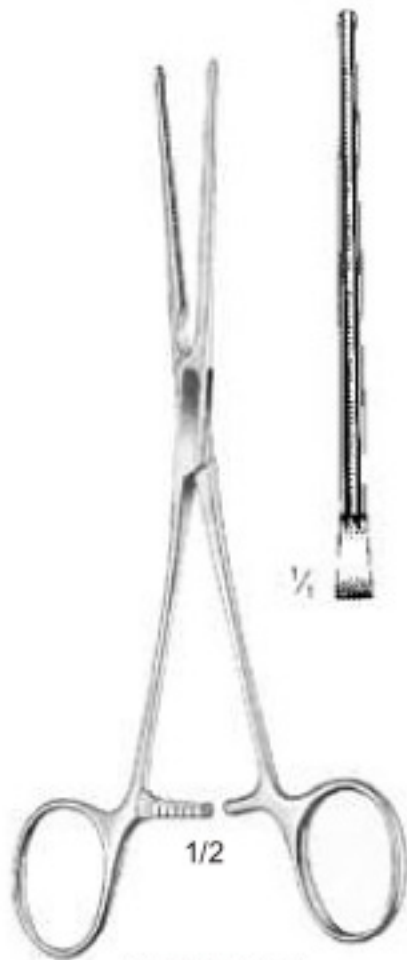

**DE BAKEY  
6044**  
170mm (6.1/4")

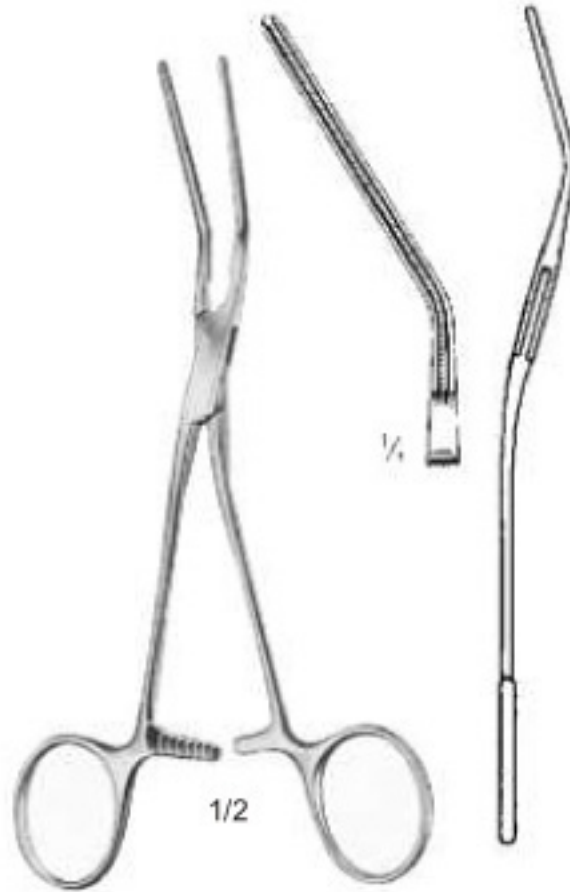

**DE BAKEY  
6045**  
160mm (6")



**DE BAKEY  
6046**  
150mm (6")



**DE BAKEY  
6047**  
150mm (6")



**DE BAKEY  
6048**  
170mm (6.1/4")



# ATRAUMA CARDIOVASCULAR FORCEPS

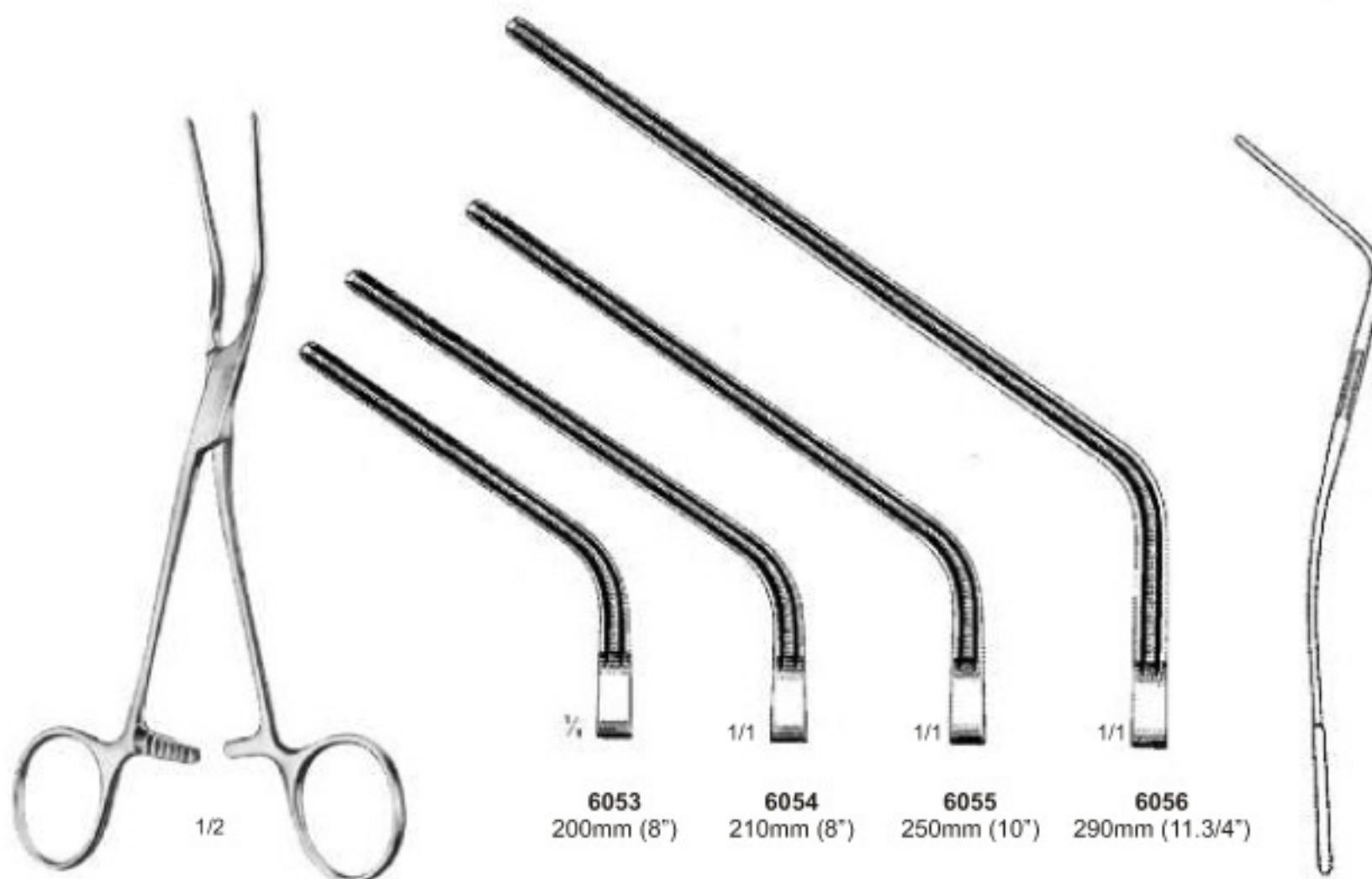
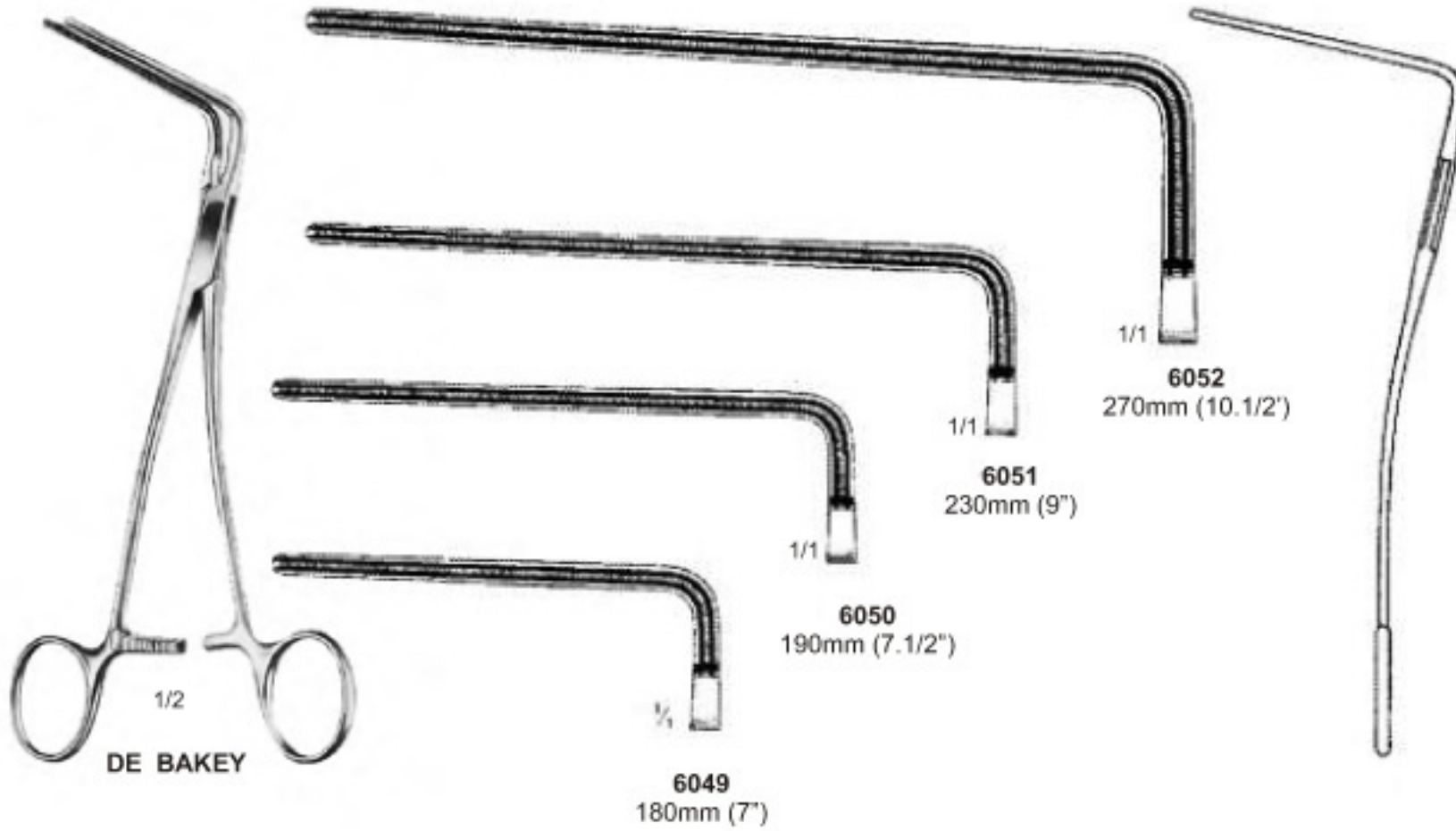



**6057**  
240mm (9.1/2")

**6058**  
240mm (9.1/2")

**6059**  
240mm (9.1/2")

**6060**  
240mm (9.1/2")



1/1



1/1



1/2

**WEBER  
6061**  
260mm (10.1/4")  
Left



1/2

**WEBER  
6062**  
260mm (10.1/4")  
Right





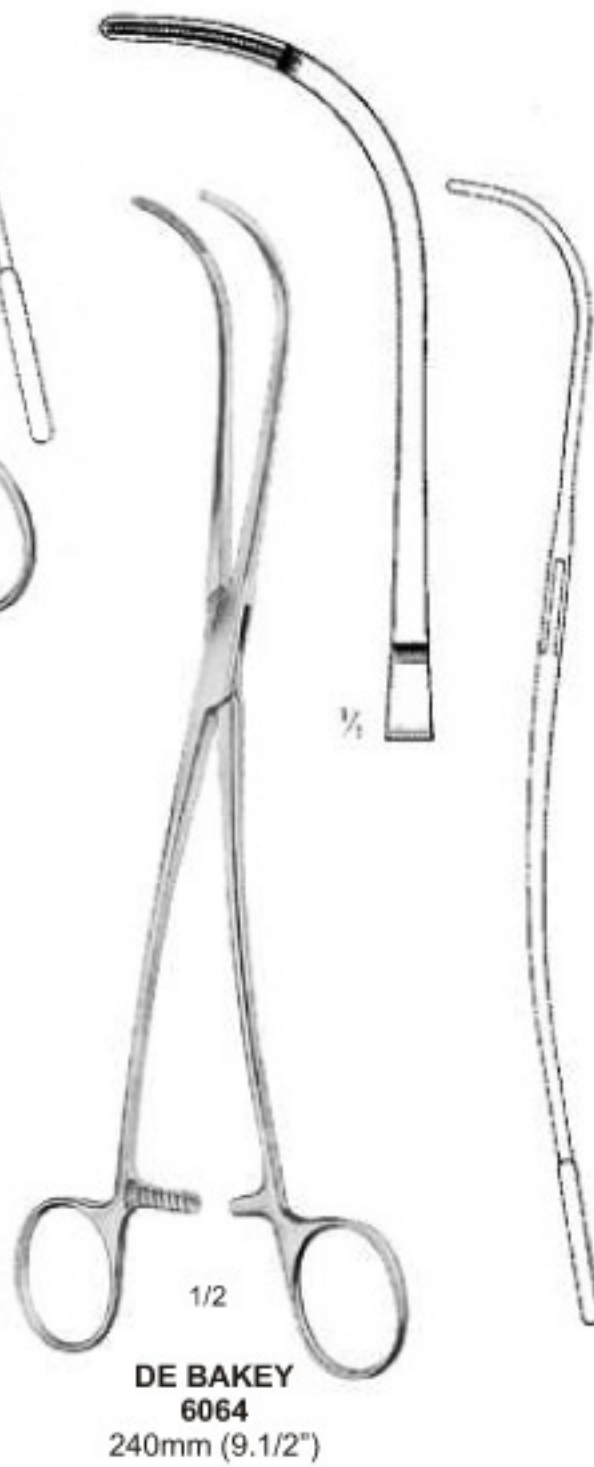
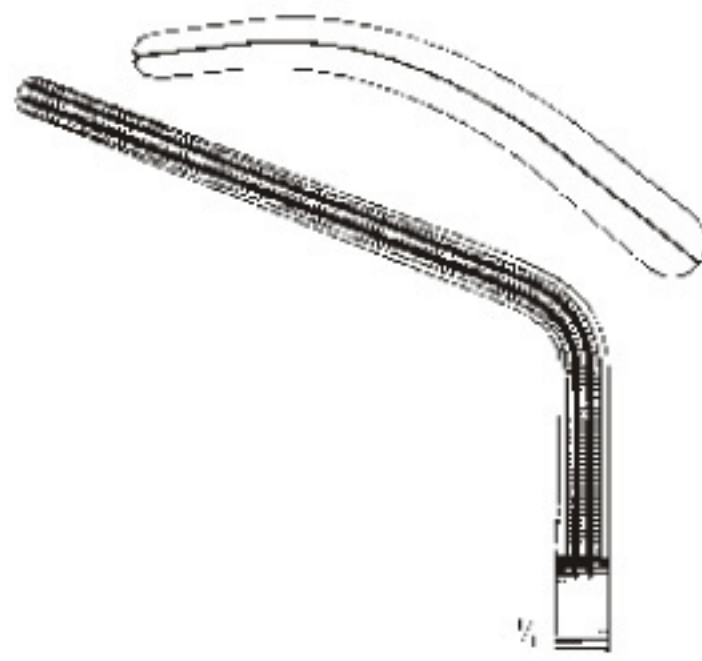



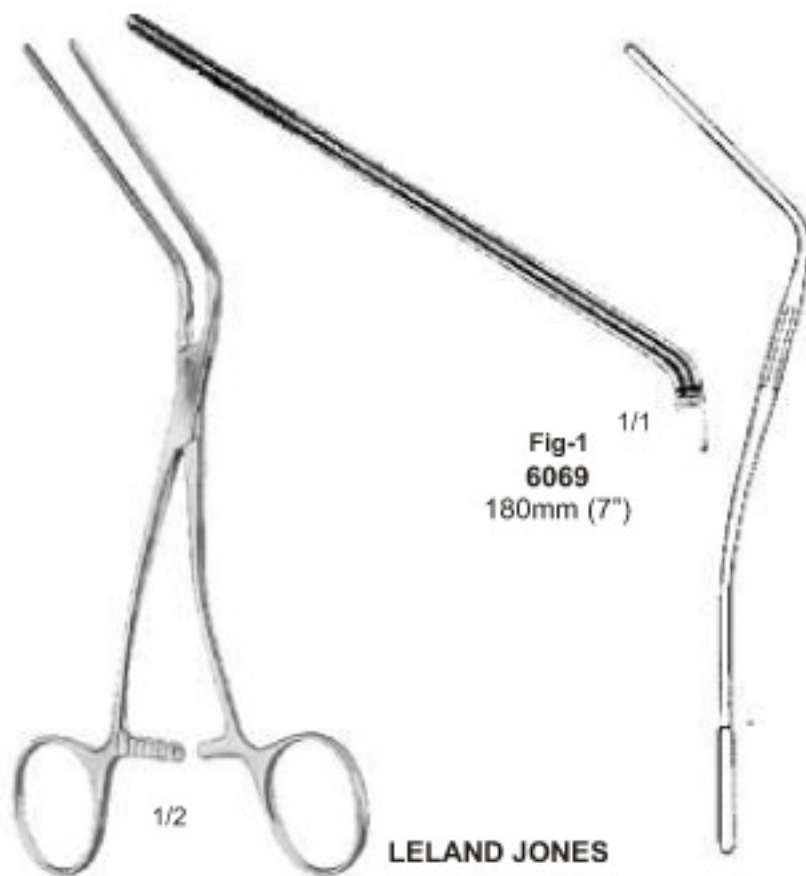
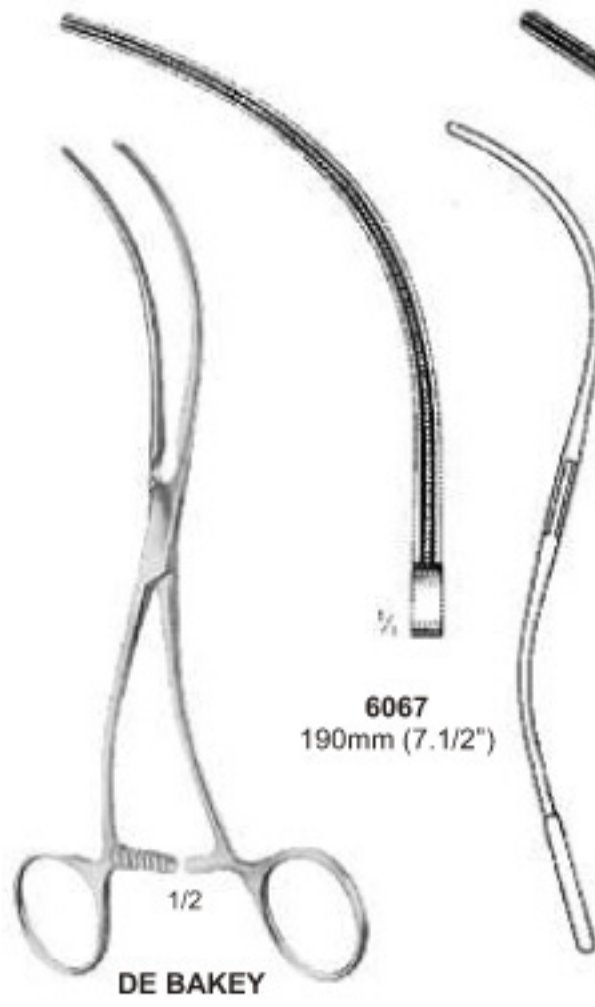
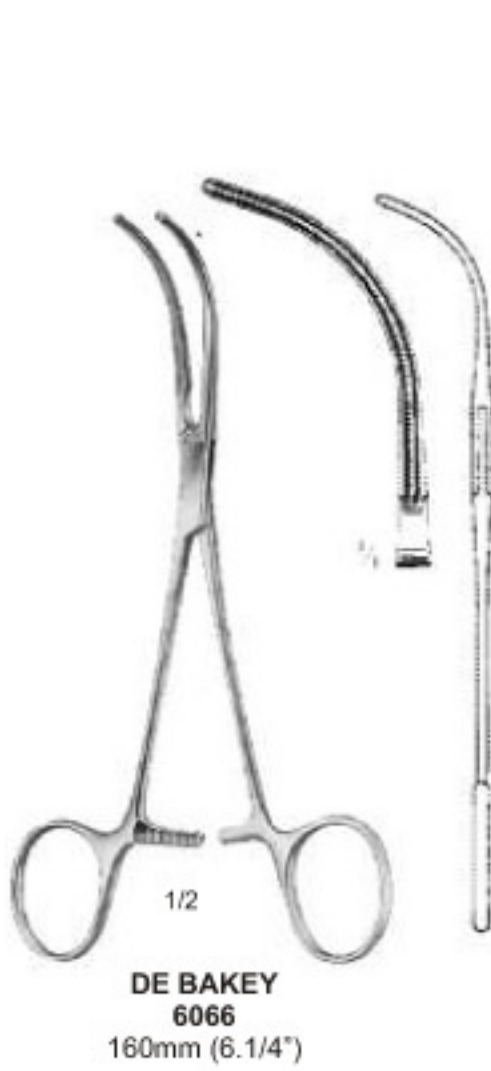





1/1

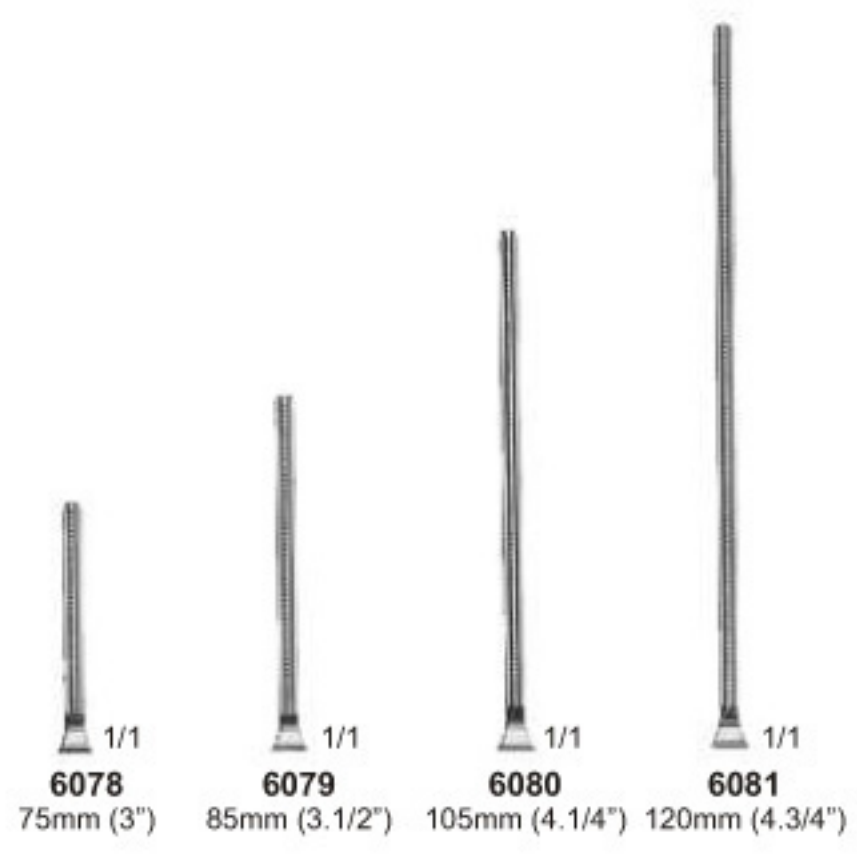

**6078** 1/1  
75mm (3")

**6079** 1/1  
85mm (3.1/2")

**6080** 1/1  
105mm (4.1/4")

**6081** 1/1  
120mm (4.3/4")

**DEBAKEY BULLDOG CLAMPS**



1/1

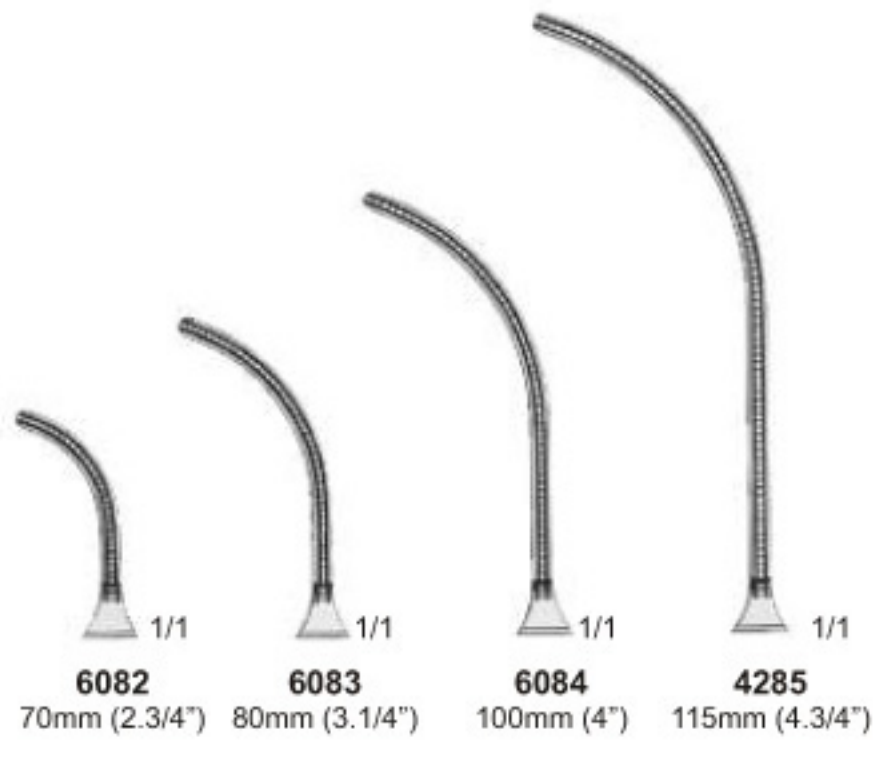

**6082** 1/1  
70mm (2.3/4")

**6083** 1/1  
80mm (3.1/4")

**6084** 1/1  
100mm (4")

**4285** 1/1  
115mm (4.3/4")

**DEBAKEY BULLDOG CLAMPS**



**APPLYING FORCEPS  
6086**  
230mm (9")





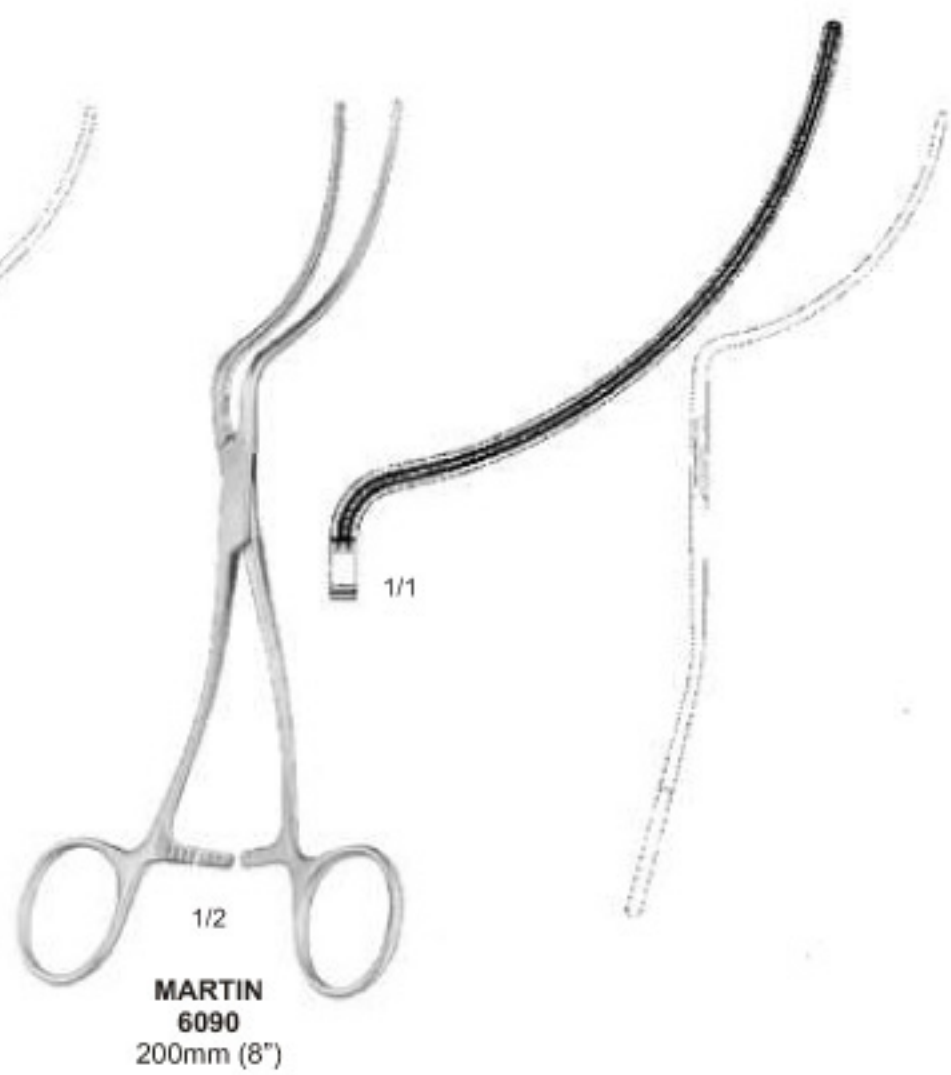
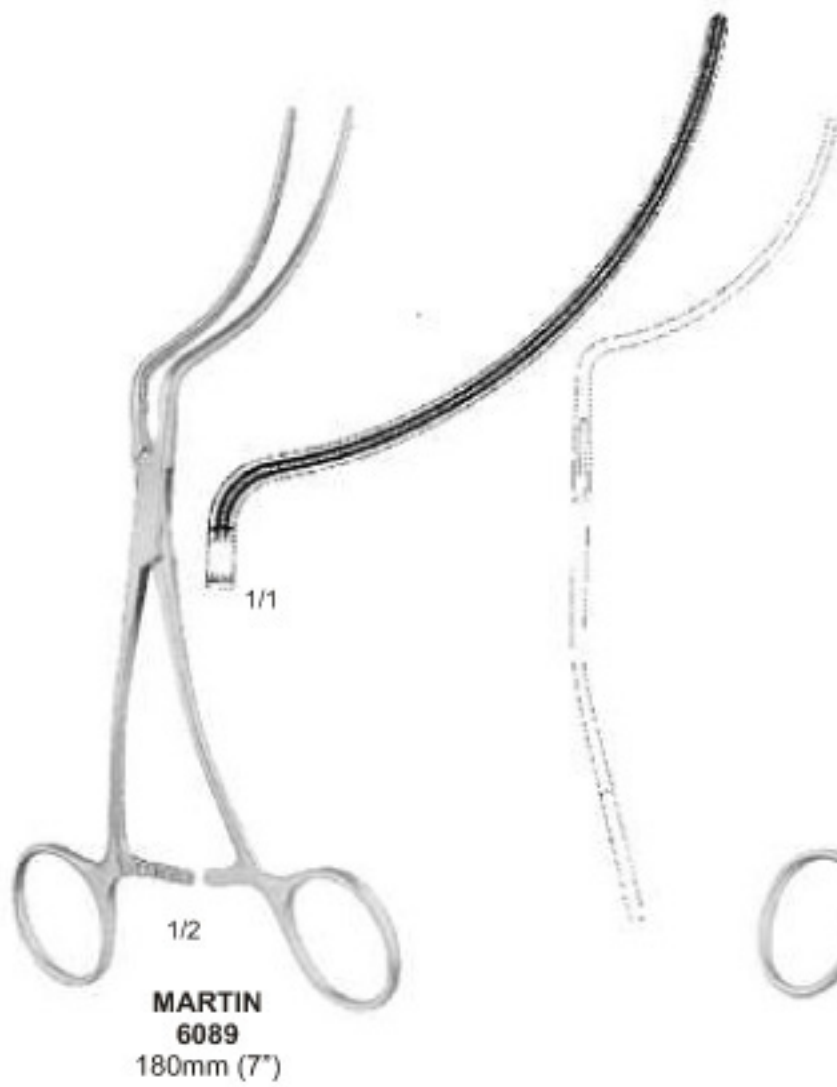
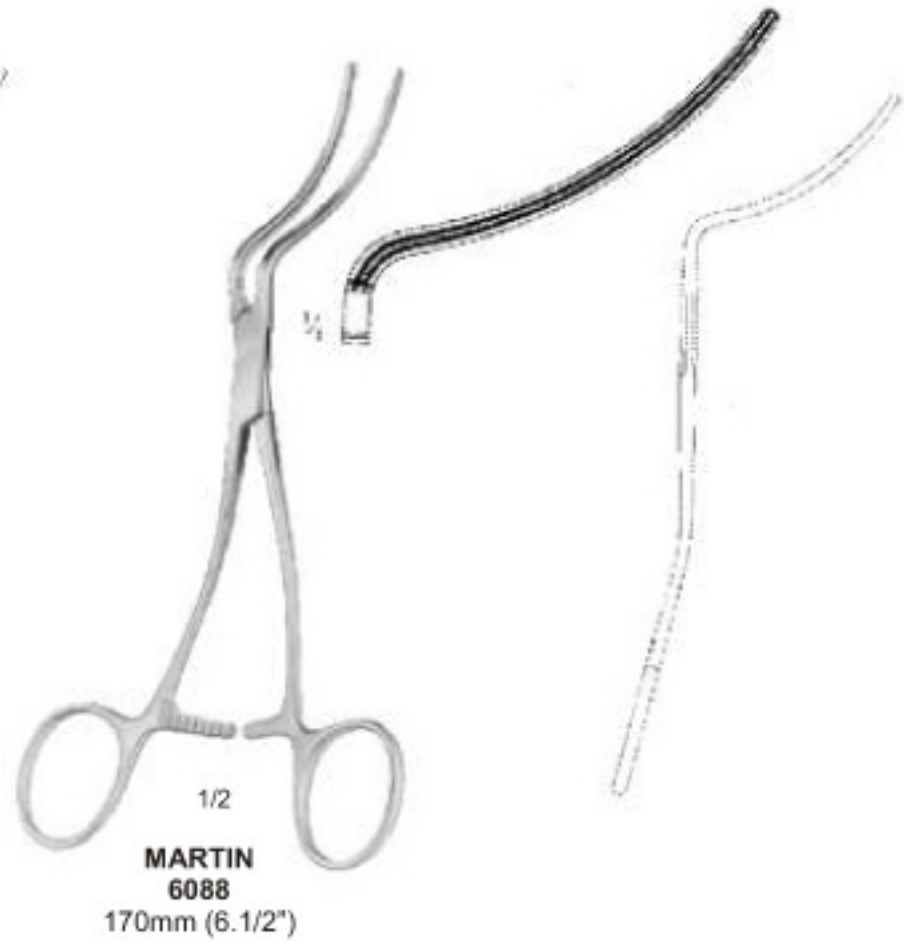
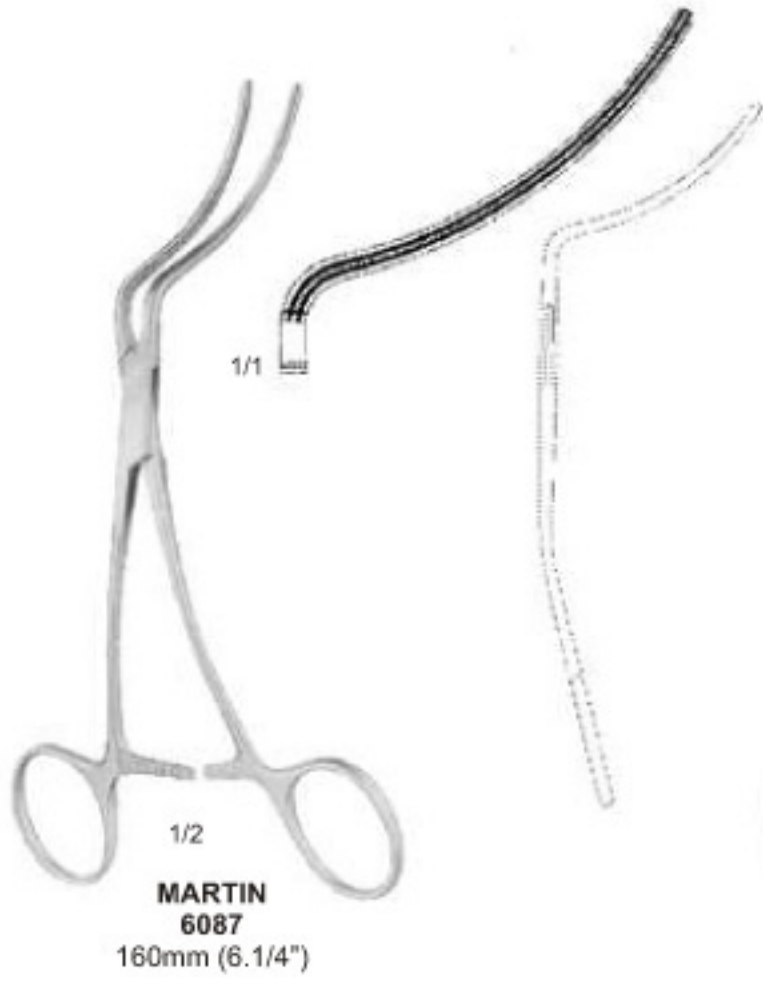





**A**

AUFRICHT (SCISSORS)	19
AMERICAN PATTERN UMBILICAL (SCISSORS)	19
ALLIS (TC DISSECTING FORCEPS)	38
ADSON (TC DISSECTING FORCEPS)	40
ARTHURE (SPLINTER FORCEPS)	45
ADSON (TOOTHED DISSECTING FORCEPS)	47
ADSON-BROWN (TOOTHED DISSECTING FORCEPS)	47
ALLIS (TISSUE FORCEPS)	59
AMERICAN PATTERN ALLIS (TISSUE FORCEPS)	59
ARRUGA (MICRO NEEDLE HOLDERS)	80
ANEL LACHRYMAL (PROBES)	91
ADSON SELF RETAINING RETRACTORS)	96
ALLISON (HAND HELD RETRACTORS)	104
ABDOMINAL RETRACTOR (HAND HELD RETRACTORS)	108
AUVARD (VAGINAL RETRACTOR/UTERINE DILATORS)	130
AMNIOTOME (UTERINE CANNULAE)	149
ADSON (RASPATORIES)	161
AMPUTATION SAW (AMPUTATION INSTRUMENTS)	165
ARMY REGULATION (AMPUTATION INSTRUMENTS)	165
ADSON FRAZIER (SUCTION TUBES)	167
ADSON (SUCTION TUBES)	167
APPLYING FORCEPS (ATRAUMA BULLDOG CLAMPS)	195

**B**

BARRON (SURGICAL HANDLES)	12
BRAUN STADTLER EPISIOTOMY (SCISSORS)	19
BABY METZANBAUM (TC SCISSORS)	26
BABY METZENBAUM (TC SCISSORS)	34
BABCOCK (TC DISSECTING FORCEPS)	38
BABY - ADSON (DISSECTING & LIGATURE FORCEPS)	44
BONNEY (TOOTHED DISSECTING FORCEPS)	46
BICKFORD (TOOTHED DISSECTING FORCEPS)	46
BONNEY (SERRATED DISSECTING FORCEPS)	53
BICKFORD (SERRATED DISSECTING FORCEPS)	53
BABY-CRILE (HAEMOSTATS FORCEPS)	65,66
BOZEMANN ( DRESSING FORCEPS)	67
BALL AND SOCKET (TOWEL CLAMPS)	69
BACKHAUS (TOWEL CLAMPS)	69
BARRAQUER (MICRO NEEDLE HOLDERS)	80
BABY-CRILE-WOOD (TC NEEDLE HOLDERS)	87
BAUMGARTNER (TC NEEDLE HOLDERS)	87
BRODIE (PROBES)	92
BECKMANN-ADSON SELF RETAINING RETRACTORS)	96
BERKELEY ABDOMINAL (SELF RETAINING RETRACTORS)	101
BALLANCE (HAND HELD RETRACTORS)	110
BLAKE (CHOLECYSTECTOMY AND GALL STONE FORCEPS)	125
BLADDER SPATULA (UROLOGY)	139
BARRON (PROCTOLOGY HAEMORRHOIDAL LGATORS)	141
BARNES (UTERINE CANNULAE)	149
BURKE (CERVICAL BIOPSY FORCEPS)	152
BONNEY POLYPI (OVUM FORCEPS)	153
BOYD BONE CURETTE (RASPATORIES)	159
BRISTOW (RASPATORIES)	160
BLAKE (AMPUTATION INSTRUMENTS)	166
BARRON (SUCTION TUBES)	168
BELUCCI (SUCTION TUBES)	168
BELUCCI SUCTION TUBE (SUCTION TUBES)	168
BURFORD (RIB SPREADERS)	173
BECK RONGEUR (DISC RONGEURS)	178
BEYER (BONE RONGEURS)	181

**C**

COBBETT (SKIN GRAFTING KNIVES)	14
CRAFOORD (SCISSORS)	18
COUNTER SCISSORS (SCISSORS)	23
CUSHING (TC DISSECTING FORCEPS)	40
CUSHING (TC DISSECTING FORCEPS)	37
CANADIAN (TOOTHED DISSECTING FORCEPS)	46
CAIRNS (DOTT) (DELICATE DISECTING FORCEPS)	50
CANADIAN (SERRATED DISSECTING FORCEPS)	55
CHAPUT (POIRIER) (TISSUE FORCEPS)	57,58
CAIRNS (HAEMOSTATS FORCEPS)	64
CRAFOORD (HAEMOSTATS FORCEPS)	64
CRILE (HAEMOSTATS FORCEPS)	64
COLLIN TONGUE FORCEPS (TONGUE DEPRESSORS)	70
CRILE WOOD (NEEDLE HOLDERS)	77
CRILE MURRAY (NEEDLE HOLDERS)	77
CONVERSE (NEEDLE HOLDERS)	78
CASTROVIEJO (MICRO NEEDLE HOLDERS)	80
COMBINED SCISSOR (TC NEEDLE HOLDERS)	82
CRILE - WOOD (TC NEEDLE HOLDERS)	86
CONVERSE (TC NEEDLE HOLDERS)	87
CRILE - WOOD (TC NEEDLE HOLDERS)	87
COARSE (TC NEEDLE HOLDERS)	88
CASTROVIEJO (TC NEEDLE HOLDERS)	88
CHARNLEY (SELF RETAINING RETRACTORS)	94
CHARNLEY PIN (SELF RETAINING RETRACTORS)	94

CONE (SELF RETAINING RETRACTORS)	97
CZERNY (HAND HELD RETRACTORS)	110
CUSHINGS VEIN (HAND HELD RETRACTORS)	114
CUSO (VAGINAL SPECULUM)	133
CUSCO SPECULAM (VAGINAL SPECULUM)	133
CLUTTON URETHRAL SOUNDS (UROLOGY)	135
CUNNINGHAM PENILE CLAMPS (UROLOGY)	138
CZERNY RECTAL SPECULUM (PROCTOLOGY)	145
CERVICAL BIOPSY FORCEPS	150
CAPENER CHISELS (OSTEOTOMES, CHISELS & GOUGES)	157
COLLIER AND MORRIS (BONE SCOOPS)	158
CAIRNS SKULL FLAP (BONE LEVERS & ELEVATORS)	164
CONE SUCTION TUBES (SUCTION TUBES)	167
COOLEY (RIB SPREADERS)	174
CUSHING (CAIRNS) RONGEUR (DISC RONGEURS)	178
CUSHING RONGEURS (DISC RONGEURS)	178
CAIRNS (BONE RONGEURS)	181
COOLEY (VASCULAR DILATORS)	184
COOLEY (DILATORS)	185
COOLEY (ATRAUMA CARDIOVASCULAR FORCEPS)	186

**D**

DIAGNOSTICS SET	01-09
DRESSING (SCISSORS)	17
DOYEN ABDOMINAL (SCISSORS)	23
DELICATE SCISSORS (TC SCISSORS)	26
DEBAKEY (TC SCISSORS)	35
DRESSING SCISSORS (TC SCISSORS)	35
DEBAKEY (TC DISSECTING FORCEPS)	37
DUVAL (TISSUE FORCEPS)	41
DENIS BROWNE (SPLINTER FORCEPS)	45
DISSECTING FORCEPS (TOOTHED DISSECTING FORCEPS)	48
DISSECTING FORCEPS (TOOTHED DISSECTING FORCEPS)	49
DISSECTING (SERRATED DISSECTING FORCEPS)	54
DISSECTING FORCEPS 55 (SERRATED DISSECTING FORCEPS)	55
DUNHILL (HAEMOSTATS FORCEPS)	61
DERF (NEEDLE HOLDERS)	78
DEBAKEY (TC NEEDLE HOLDERS)	82
DERF (TC NEEDLE HOLDERS)	86
DIRECTORS (PROBES)	92
DURHAM (HAND HELD RETRACTORS)	113
DEAVER (HAND HELD RETRACTORS)	117,118,119
DEAVER GRIP (HAND HELD RETRACTORS)	118,119
DEAVER (HAND HELD RETRACTORS)	118,119,120
DOYEN (INTESTINAL CLAMPS)	123,124
DOYEN (KOCHER) (INTESTINAL CLAMPS)	124
DOYEN (MAYO ROBSON) (INTESTINAL CLAMPS)	124
DUCT DISSECTING (CHOLECYSTECTOMY )	125
DESJARDINS (GALL DUCT PROBES)	126
DOYEN (VAGINAL SPECULUM)	132
DOYEN (OVUM FORCEPS)	153
DALE (ATRAUMA CARDIOVASCULAR FORCEPS)	170
DE-BAKEY SATINSKY (ATRAUMA BULLDOG CLAMPS)	171
DE BAKEY-CAROTIS (ATRAUMA BULLDOG CLAMPS)	171
DE BAKEY SATINSKY (ATRAUMA BULLDOG CLAMPS)	171
DE BAKEY (VASCULAR DILATORS)	184
DE BAKEY (ATRAUMA CARDIOVASCULAR FORCEPS)	187,188,189
DE BAKEY (ATRAUMA CARDIOVASCULAR FORCEPS)	192
DE BAKEY (ATRAUMA CARDIOVASCULAR FORCEPS)	193
DEBAKEY BULLDOG CLAMPS (ATRAUMA BULLDOG CLAMPS)	195

**E**

ERGONOMIC (SURGICAL HANDLES)	10
EXTRA FINE (DELICATE DISECTING FORCEPS)	50

**F**

FAVALORO (ORAL SCISSORS)	22
FINE CURVED (DISSECTING & LIGATURE FORCEPS)	43
FEILCHENFEL (SPLINTER FORCEPS)	45
FINE (TOOTHED DISSECTING FORCEPS)	46
FORCEPS (SERRATED DISSECTING FORCEPS)	54
FRASER-KELLY (CRILE) (HAEMOSTATS FORCEPS)	61
FRASER - ADSON (HAEMOSTATS FORCEPS)	61
FORESTER (SPONGE HOLDING FORCEPS)	68
FLAT TONGUE DEPRESSOR (TONGUE DEPRESSORS)	71
FINE (TC NEEDLE HOLDERS)	88
FINSON (SELF RETAINING RETRACTORS)	98
FEMALE CATHETERS (UROLOGY)	135
FAURE (PERITONEUM INSTRUMENTS)	147
FRENCH MODEL PELVIMETER (UTERINE CANNULAE)	149
FREER ELEVATOR (RASPATORIES)	161
FINGER SAW (AMPUTATION INSTRUMENTS)	165
FRAZIER (SUCTION TUBES)	167
FORMBY (SUCTION TUBES)	168



## G

GILLIES (TOOTHED DISSECTING FORCEPS)	48
GILLIES (NEEDLE HOLDERS)	76
GILLIES (TC NEEDLE HOLDERS)	82
GWYNNE EVANS TONSIL (DISSECTORS)	89
GELPI VULVA (SELF RETAINING RETRACTORS)	98
GOLIGHER (SELF RETAINING RETRACTORS)	101
GOSSET (Rereactor)	102
GEARY GRANT (CHOLECYSTECTOMY & GALL STONE)	128
GRAVE (VAGINAL SPECULUM)	134
GABRIEL METAL (HAEMORRHOIDAL SYRINGES)	140
GABRIEL NEEDLES (HAEMORRHOIDAL SYRINGES)	140
GABRIEL SYRINGES (HAEMORRHOIDAL SYRINGES)	140
GABRIEL METAL AND GLASS SYRINGE SET (HAEMORRHOIDAL SYRINGES)	140
GRAEME ANDERSON RECTAL SPECULUM (PROCTOLOGY)	144
GABRIEL RECTAL SPECULUM (PROCTOLOGY)	144
GWILLIAM HYSTERECTOMY (HYSTERECTOMY CLAMPS)	146
GREGORY (ATRAUMA CARDIOVASCULAR FORCEPS)	169
GLOVER (ATRAUMA BULLDOG CLAMPS)	171
GREGORY-SOFT (ATRAUMA BULLDOG CLAMPS)	171
GLUCK (BONE & RIB SHEARS)	175

## H

HEYMANN TURBINECTOMY (ORAL, DELICATE SCISSORS)	21
HEDGEMAN (DIETRICH) (ORAL SCISSORS)	22
HYSTERECTOMY SCISSORS (TC SCISSORS)	29
HYSTERECTOMY (TC SCISSORS)	29
HUNTER (SPLINTER FORCEPS)	45
HALSTEAD MOSQUITO (HAEMOSTATS FORCEPS)	65,66
HEYWOOD-SMITH TONGUE FORCEPS (TONGUE DEPRESSORS)	70
HALSEY (NEEDLE HOLDERS)	73
HEGAR (NEEDLE HOLDERS)	74
HEANEY (NEEDLE HOLDERS)	76
HAGAR-MAYO (TC NEEDLE HOLDERS)	81
HAGER-OSLEN (TC NEEDLE HOLDERS)	82
HOESEL (TC NEEDLE HOLDERS)	83
HALSEY (TC NEEDLE HOLDERS)	86
HALSEY (TC NEEDLE HOLDERS)	87
HENDERSON (SELF RETAINING RETRACTORS)	97
HARRINGTON - PEMBERTON (HAND HELD RETRACTORS)	104
HAWKIN AMBLER (VAGINAL RETRACTOR/UTERINE DILATORS)	130
HEGAR (VAGINAL RETRACTOR/UTERINE DILATORS)	130
HEYWOOD SMITH (OVUM FORCEPS)	154
HEATH (MALLETS)	156
HOHMANN (BONE LEVERS)	163
HANDLE (SUCTION TUBES)	167
HOUSE (SUCTION TUBES)	168
HEANLEY (BONE RONGEURS)	179
HARKEN (ATRAUMA CARDIOVASCULAR FORCEPS)	190

## I

IRIS (DELICATE SCISSORS)	20
IRIS SCISSORS (TC SCISSORS)	25
IRIS DELICATE (TC SCISSORS)	35
I.M.A Retractor (SELF RETAINING RETRACTORS)	94
IRWIN (SELF RETAINING RETRACTORS)	101
ISRAEL (HAND HELD RETRACTORS)	109
I.U.D. REMOVING HOOK (OBSTETRICS INSTRUMENTS)	148

## J

JEFFERSON (TOOTHED DISSECTING FORCEPS)	47
JEFFERSON (DELICATE DISSECTING FORCEPS)	50
JUD-ALLIS (TISSUE FORCEPS)	57, 58
JAMESON (NEEDLE HOLDERS)	76
JULIAN (TC NEEDLE HOLDERS)	85
JOBSON HORNE (PROBES)	91
JANSON (SHEA) (SELF RETAINING RETRACTORS)	97
JEFFERSON (SELF RETAINING RETRACTORS)	97
JACKSON - BURROWS (SELF RETAINING RETRACTORS)	98
JOLL THYROID (SELF RETAINING RETRACTORS)	99
JOSEPH (RASPATORIES)	161
JAVID (ATRAUMA CARDIOVASCULAR FORCEPS)	169
JANSEN-MIDDLETON SEPTUM FORCEPS (BONE RONGEURS)	181

## K

KILNER (SCISSORS)	19
KOCHER (HAEMOSTATS FORCEPS)	62
KELLY (HAEMOSTATS FORCEPS)	63
KOCHER (HAEMOSTATS FORCEPS)	63
KELLY HALSTEAD (HAEMOSTATS FORCEPS)	63
KILNER (NEEDLE HOLDERS)	76
KILNER (TC NEEDLE HOLDERS)	81
KOCHER THYROID (DISSECTORS)	90
KIRSCHNER RETRACTOR SET (Rereactor)	102
KOCHER BONE HOOK (HAND HELD RETRACTORS)	106
KOCHER (HAND HELD RETRACTORS)	114
KOCHER (HAND HELD RETRACTORS)	116
KRISTELLE (VAGINAL SPECULUM)	131
KOGAN ENDOCERVICAL SPECULUM (VAGINAL SPECULUM)	132
KELLY PROCTOSCOPE (PROCTOLOGY)	144
KIELLAND (OBSTETRICS INSTRUMENTS)	143
KEVORKIAN (CERVICAL BIOPSY FORCEPS)	151
KEVORKIAN (CERVICAL BIOPSY FORCEPS)	152
KELSEY FRY (MALLETS)	155
KILLEARN (BONE RONGEURS)	179

## L

LLOYD DAVIS RECTAL (SCISSORS)	11
LISTER BANDAGE (SCISSORS)	21
LEXER (TC SCISSORS)	29
LEXER (TC SCISSORS)	32
LUCAE (TC DISSECTING FORCEPS)	37
LANE (TISSUE FORCEPS)	42
LIGATURE FORCEPS (DISSECTING & LIGATURE FORCEPS)	44
LANE (TOOTHED DISSECTING FORCEPS)	49
LITTLEWOOD (TISSUE FORCEPS)	56
LITTLEWOOD (TISSUE FORCEPS)	57
LLOYD DAVIS (HAEMOSTATS FORCEPS)	62
LACK TONGUE DEPRESSOR (TONGUE DEPRESSORS)	71
LAWRANCE (NEEDLE HOLDERS)	72
LITTLEWOOD (TISSUE FORCEPS)	79
LIEBRICH LACHRYMAL (PROBES)	91
LANGENBECK BONE HOOK (HAND HELD RETRACTORS)	106
LEMPERT (HAND HELD RETRACTORS)	110
LANGENBECK (HAND HELD RETRACTORS)	115
LANE TWIN ANASTOMOSIS (INTESTINAL CLAMPS)	121
LLOYD DAVIS RECTAL OCCLUSION (INTESTINAL CLAMPS)	122
LOWER (CHOLECYSTECTOMY & GALL STONE)	128
LAHEY (CHOLECYSTECTOMY & GALL STONE)	128
LLOYD DAVIES (SIGMOIDOSCOPY / BIOSPY)	142
LLOYD DAVIES (SIGMOIDOSCOPY)	143
LUCAE (MALLETS)	156
LEMPERT (BONE SCOOPS)	158
LANGENBECK (RASPATORIES)	160
LAMBOTE (RASPATORIES)	160
LANE BONE LEVER (BONE LEVERS & ELEVATORS)	164
LISTON (AMPUTATION INSTRUMENTS)	166
LANGENBECK (AMPUTATION INSTRUMENTS)	166
LEKSELL (BONE RONGEURS)	179
LUER (BONE RONGEURS)	181
LEWIN (BONE HOLDING FORCEPS)	182
LELAND JONES (ATRAUMA CARDIOVASCULAR FORCEPS)	193

## M

MAYO (SCISSORS)	15
MAYO HARRINGTON (SCISSORS)	16
MAYO (STILLE) (SCISSORS)	16
METZENBAUM (SCISSORS)	17
METZENBAUM (Nelson) (SCISSORS)	17
MCINDOE SCISSORS (SCISSORS)	24
MAYO DISSECTING SCISSORS (TC SCISSORS)	26
METZENBAUM (TC SCISSORS)	27
MAYO-LEXER (TC SCISSORS)	29
METZENBAUM (TC SCISSORS)	30,31
MCINDOE SCISSORS (TC SCISSORS)	31
MAYO - LEXER (TC SCISSORS)	32
METZENBAUM (TC SCISSORS)	33
MAYO (TC SCISSORS)	34
METZENBAUM DELICATE (TC SCISSORS)	34
METZENBAUM (TC SCISSORS)	34
METZENBAUM (TC SCISSORS)	36
MAYO (TC SCISSORS)	36
Mcindoe (TC SCISSORS)	36
MERIAM (TC DISSECTING FORCEPS)	37
MICRO ADSON (DISSECTING & LIGATURE FORCEPS)	44
MICRO SOFT TOUCH RING TIP (SPLINTER FORCEPS)	45
MICINDOE (TOOTHED DISSECTING FORCEPS)	48
MACINDOE (DELICATE DISSECTING FORCEPS)	51









**U**

UTERINE (SCISSORS)	18
UTERINE (SCISSORS)	19

**V**

VASCULAR SCISSORS (TC SCISSORS)	35
VACUME EXTRACTION SUCTION HEAD (UTERINE CANNULAE)	149
VOLKMANN (RASPATORIES)	159
VERBRUGGE (BONE HOLDING FORCEPS)	182

**W**

WATSON (SKIN GRAFTING KNIVES)	14
WOODS TONSIL (ORAL SCISSORS)	22
WHEELER TONSIL (ORAL SCISSORS)	22
WILSON TONSIL (ORAL SCISSORS)	22
WANGENSTEEN (TC DISSECTING FORCEPS)	39
WAUGH (TOOTHED DISSECTING FORCEPS)	47
WAUGH (DELICATE DISSECTING FORCEPS)	51
WEBSTER (NEEDLE HOLDERS)	72
WARD (NEEDLE HOLDERS)	75
WRIGHT (NEEDLE HOLDERS)	76
WANGENSTEEN (NEEDLE HOLDERS)	77
WEBSTER (TC NEEDLE HOLDERS)	87
WATSON CHEYNE (DISSECTORS)	90
WALACE MODIFIED (SELF RETAINING RETRACTORS)	95
WEISLANDER (SELF RETAINING RETRACTORS)	100
WERTHEIM (HAND HELD RETRACTORS)	107
WALTON RECTAL (SIGMOIDOSCOPY / BIOSPY)	142
WRIGLEY (OBSTETRICS INSTRUMENTS)	148
WITTNER (CERVICAL BIOPSY FORCEPS)	151
WILLIGER (BONE LEVERS)	162
WILMS (BONE RONGEURS)	179
WEBER (ATRAUMA CARDIOVASCULAR FORCEPS)	191

**Y**

YEOWMAN BIOPSY FORCEPS (PROCTOLOGY HAEMORRHOIDAL LGATORS)	141
---	-----

**Z**

ZWEIFEL (TC NEEDLE HOLDERS)	84
ZOELLNER DETACHABLE ENDS (SUCTION TUBES)	168







**Address: Model Town, Ugoki Road, Sialkot Pakistan.**

**Mob: +92 349 4368 420**

**Email: [marketing4propas@gmail.com](mailto:marketing4propas@gmail.com)  
Email: [info@propasintl.com.pk](mailto:info@propasintl.com.pk)**

**Website: [www.propasintl.com.pk](http://www.propasintl.com.pk)**